

UNIT-IV IDEAL & REAL GASES AND THERMO DYNAMIC RELATIONS**9(L)+3(T)**

Gas mixtures – Properties of ideal and real gases, equation of state, Avagadro's law, Vander Waal's equation of states, compressibility, compressibility chart. Dalton's law of partial pressure, Exact differentials, T-D, relations, Maxwell relations, Clausius Clapeyron equations, Joule Thomson Coefficient.

UNIT-V PSYCHROMETRY**9(L)+3(T)**

Psychrometry and psychrometric charts, property calculations of air vapour mixtures. Psychrometric process – Sensible heat exchange processes. Latent heat exchange processes. Adiabatic mixing, evaporative cooling, problems.

TUTORIALS 15**TOTAL : 60**

(Use of standard thermodynamic tables, Mollier diagram, Psychometric chart and Refrigerant are permitted)

TEXT BOOKS

1. Nag.P.K., "Engineering Thermodynamics", Tata McGraw-Hill, New Delhi, 2007.
2. Rathakrishnan E., "Fundamentals of Engineering Thermodynamics", Prentice-Hall of India, 2005.

REFERENCES

1. Ramalingam K.K. "Thermodynamics", Sci-Tech Publications, 2006
 2. Holman.J.P., "Thermodynamics", 3rd Ed. McGraw-Hill, 2007.
 3. Venwylen and Sontag, "Classical Thermodynamics", Wiley Eastern, 1987
 4. Arora C.P, " Thermodynamics", Tata McGraw-Hill, New Delhi, 2003.
 5. Merala C, Pother, Craig W, Somerton, " Thermodynamics for Engineers", Schaum Outline Series, Tata McGraw-Hill, New Delhi, 2004.
-

CHAPTER 1 Basic Concept & First law

What is Thermodynamics?

For a wide range of engineering plant like steam turbines, reciprocating engines, turbo-jets, rockets, combustion systems etc., we are concerned with the transfer of heat and work. In many cases the objective is to convert one form of energy to another. Thermodynamics is science of **energy** and **entropy**. “**Thermodynamics is the science that deals with *heat and work* and those *properties* of substances that bear a relation to heat and work.**”

Some keywords:

- **Properties:** density, temperature, pressure, ...
- **State:** a collection of properties
- **Process:** a path between states
- **Energy:** heat, work, internal energy, enthalpy
- **Entropy:** degree of disorder

What will we learn?

- Identification of thermodynamic properties and states
- Basic laws
 - Zeroth law : equality of temperature (thermal equilibrium)
 - 1st law : conservation of energy
 - 2nd law : conservation of entropy
- System and control volume analysis
- Directionality of process
- Efficiency analysis
- Practical devices and cycles

All the above laws were derived from experience without mathematical proofs.

Before going into the analysis of such changes, it is necessary to introduce some basic concepts.

System / Control Volume

For defining the object under study, we draw a boundary around what we wish to study.

A system is a region of space containing a quantity of matter whose behaviour is being investigated. This quantity of matter is separated from the surroundings by a **boundary**, which

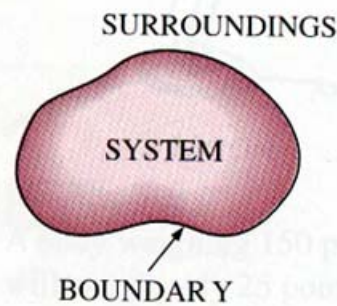
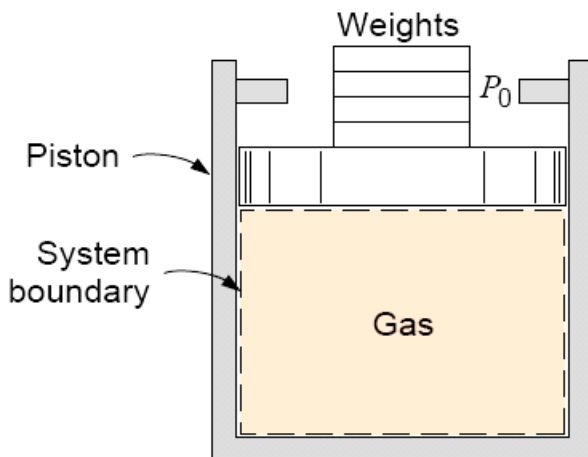

System, surroundings, and boundary.

may be a physical boundary like walls of a vessel, or some imaginary surface enveloping the region. The term **surroundings** is restricted to those portions of the matter external to the system, which are affected by changes occurring within the system. Before any thermodynamic analysis is attempted, it is necessary to define the boundary of the system because it is across the boundary that **work**, **heat** and **mass** are said to be transferred.

Now let us see what is happening at the boundary? Can work, heat, mass cross the boundary?

This makes for different definitions of the systems:

Definition		Work	Heat	Mass
Isolated system		No	No	No
Closed system	Also called Control Mass	Yes	Yes	No
Open system	Also called Control Volume	Yes	Yes	Yes

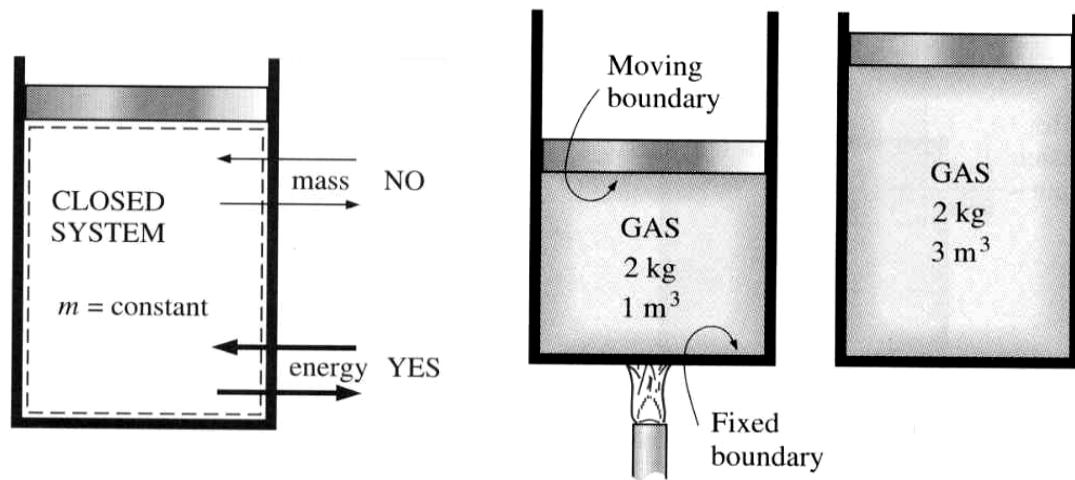

A closed system with moving boundary

Fig. Examples of Closed System

When the same matter remains within the region throughout the process under investigation it is called **closed system**. In this case, **only heat and work** cross the boundary.

An **open system** is a region in space defined by a boundary across which the matter may flow in addition to work and heat.

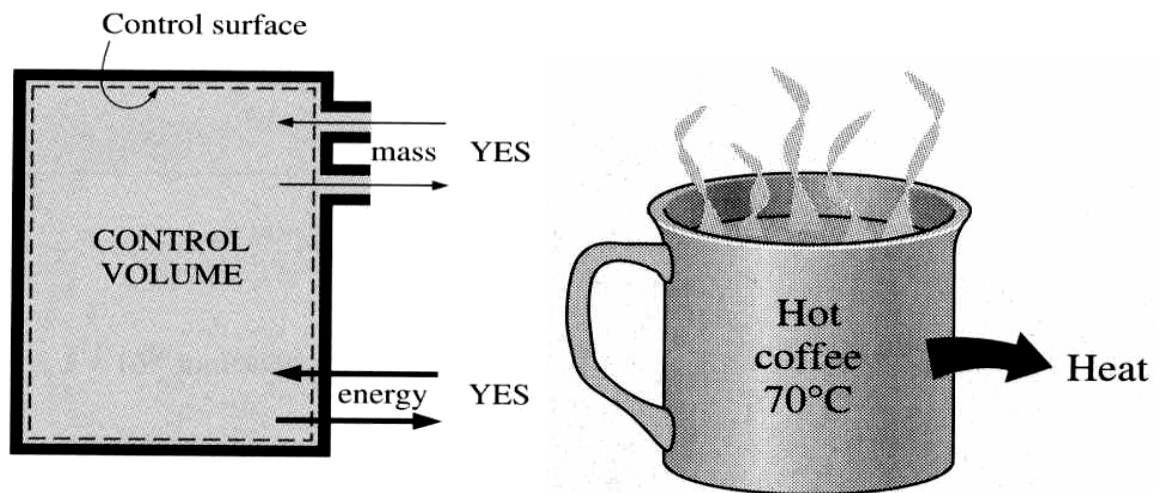

Both mass and energy can cross the boundaries of a control volume.

Fig. Examples of Open System

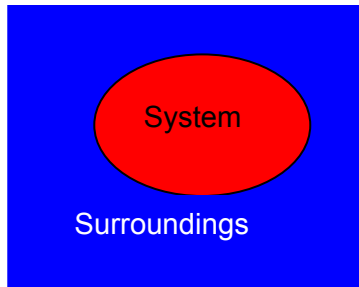

Fig. Isolated systems

The **isolated system** is one in which there is no interaction between the system and surroundings. There is no mass or energy transfer across the system boundary.

Examples of open system \Rightarrow flow nozzles, steam turbine, boiler etc.

Examples of closed system \Rightarrow mixer of water and steam in a closed vessel, a gas expanding in a cylinder by displacing a

piston. Hence, for a closed system, boundary need not be fixed; it may contract or expand to accommodate any change in volume undergone by a fixed quantity of fluid.

The processes undergone in a closed system \Rightarrow **non-flow process**.

The processes undergone in an open system \Rightarrow **flow process**.

State, Property, Path, Process

The idea of system is defined in the introduction. A closed system is fully defined when the following details are known:

- The fluid, i.e. whether gas, water etc.
- The boundary between the fluid under consideration and its surroundings
- The mass of the fluid within the boundary.

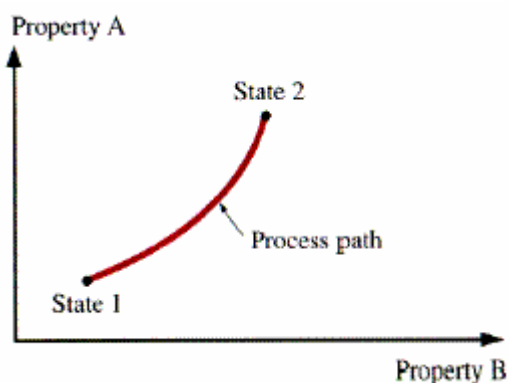

Every system has certain characteristics by which its physical condition may be described, e.g. volume, temperature, pressure etc. Such characteristics are called **properties** of the system. These are all **macroscopic** in nature. When all the properties of a system have definite values, the system is said to exist at a definite **state**. Any operation in which one or more properties of a system change is called a **change of state**. The succession of states passed

through during a change of state is called the **path** of the change of state. When the path is completely specified, the change of state is called a **process**, e.g. a constant pressure process.

The value of property does not depend on process through which the fluid is passed. The change in the value of property depends on the initial and final states of the system. Pressure, specific volume and temperature are some examples of basic properties. Three more properties- internal energy, enthalpy and entropy emerge as a consequence of First and Second Laws of Thermodynamics. From these six properties, only two may be selected to determine the state of a closed system in thermodynamic equilibrium and the remaining four values are then fixed. Care must be taken to see that the two properties are independent of each other, i.e. it must be possible to vary one of these properties without changing the other. For example, when a liquid is in contact with its vapour in a closed vessel it is found that the temperature at which the liquid and vapour in equilibrium is always associated with a particular pressure and one cannot change one without the other. Pressure and temperature cannot be used to determine the state of such systems. However, pressure and specific volume may be used to define the state of such system. **It follows that the initial and final states of any closed system can be located as points on a diagram using two properties as coordinates.** Properties may be of two types. ***Intensive (Intrinsic) properties*** are independent of mass of the system, e.g. pressure, temperature, etc. ***Extensive properties*** are related to the mass of the system, e.g. volume, energy etc.

Equilibrium

By specifying the P , T , ρ and V , the state of the system is defined.

Two adjacent systems (or system and surroundings) left for a long time will reach equilibrium.

A system is said to be in ***thermodynamic equilibrium*** if no further changes occur within it when it is isolated from the surroundings in such a way that no heat and work can cross the boundary. The properties must be uniform throughout the system when it is in equilibrium. Only under conditions of equilibrium can a single values of pressure or temperature be ascribed to the system, and thus be used to determine its state.

For a system to be in equilibrium, system must be in ***mechanical, thermal and chemical equilibrium***.

If the system is imagined to pass through a continuous series of equilibrium states during the process, the intermediate states could be located on the diagram, and a line representing the path of the process could be drawn through all the points. Such a process is called a ***reversible***

process or **quasi-static process**. However, in all real processes, the system is not in equilibrium in any of the intermediate states. These states cannot be located on the coordinate diagram because the properties do not have single unique values throughout the system. Such processes are called **irreversible processes**.

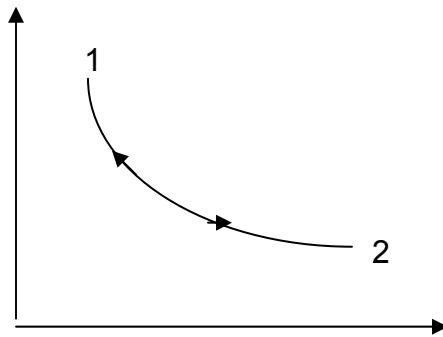

Reversible Process

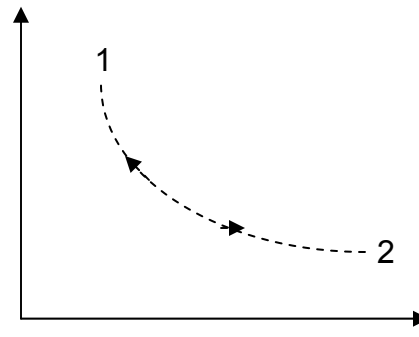

Irreversible Process

Mechanical Equilibrium: Force Balance

For a system to be in mechanical equilibrium, summation of all the forces acting on the body should be zero i.e. $\sum F = 0$ if acceleration is zero (Newton's second law)

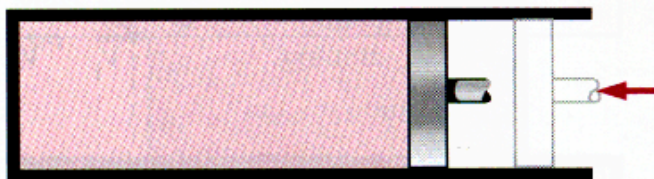
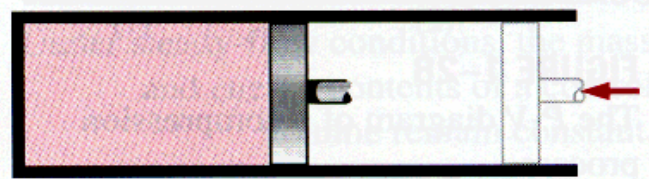
(a) Slow compression
(quasi-equilibrium)(b) Very fast compression
(non-quasi-equilibrium)

– **Quasi-equilibrium versus non-equilibrium**

Quasi-equilibrium: if the process is slow enough, the system is considered approximately in equilibrium at each time.

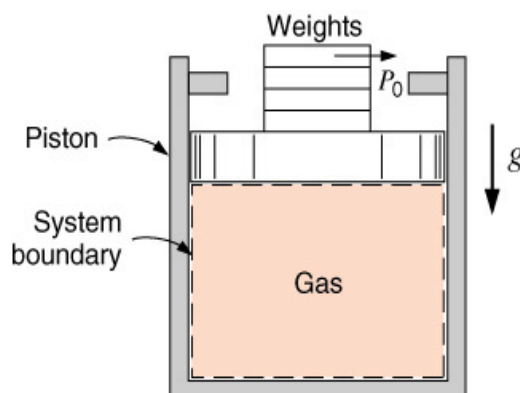

For example, remove weights one by one. Each time the system reaches equilibrium instantaneously. This process is called Quasi-Equilibrium Process.

If you remove weights all at once, Process is difficult to describe. Then it is *Non equilibrium process*.

How slow is slow?

Relative to the relaxation time scales for pressure (speed of sound), temperature (molecular collision), etc. These time scales are usually very short, so the quasi-equilibrium approximation is valid (even for reciprocating engines).

Q: Can we define a path for a quasi-equilibrium process?

Q: Can we define a path for a non-equilibrium process?

Q: Can we calculate anything that happened during a non-equilibrium process?

Thermal equilibrium

The property, which distinguishes thermodynamics from other sciences, is temperature. Temperature is associated with the ability to distinguish between hot from cold. When two bodies at different temperature are brought into contact, after some time they attain a common temperature and are said to be in **thermal equilibrium**. Two systems are said to have *equal temperatures* if there is no change in any of their observable characteristics when they are brought into contact with one another.

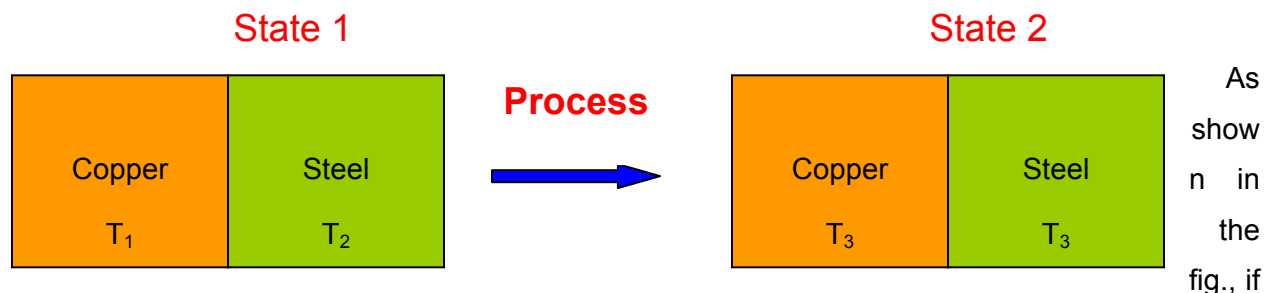

a copper body at a temperature T_1 is brought into contact of a steel body at temperature T_2 such that $T_1 > T_2$, then after some time both the bodies will be at a temperature T_3 . The temperature T_3 will be in between T_1 and T_2 . Both the bodies then can be said to be in thermal equilibrium. *If*

two bodies (A and B) are each equal in temperature to a third body (C), they (A and B) are equal in temperature to each other. This is the principle of **thermal equilibrium** and is known as **zeroth law of thermodynamics**. In other words, the zeroth law of thermodynamics states that if $T_A = T_C$ and $T_B = T_C$, then $T_A = T_B$.

The possibility of measuring the temperature rests upon this principle.

Temperature scale:

C (Celsius)	K (Kelvin)	$K = C + 273.15$
F (Fahrenheit)	R (Rankine)	$R = F + 459.67$
	$F = 32 + (9/5)C$	

Summary:

We can say that the state of a system changes when heat and work cross the boundary. Thermodynamics provides a means of relating the quantities of heat and work with the change of state. The structure of thermodynamics rests on two important principles called the First and Second Laws of Thermodynamics. These cannot be proved and are treated as axioms.

WORK and HEAT

We can now:

1. Distinguish the system from its surroundings.
2. Find the properties of the system to identify its state.

Our objective now is to find out how we can use it to produce Work and Heat that are useful in

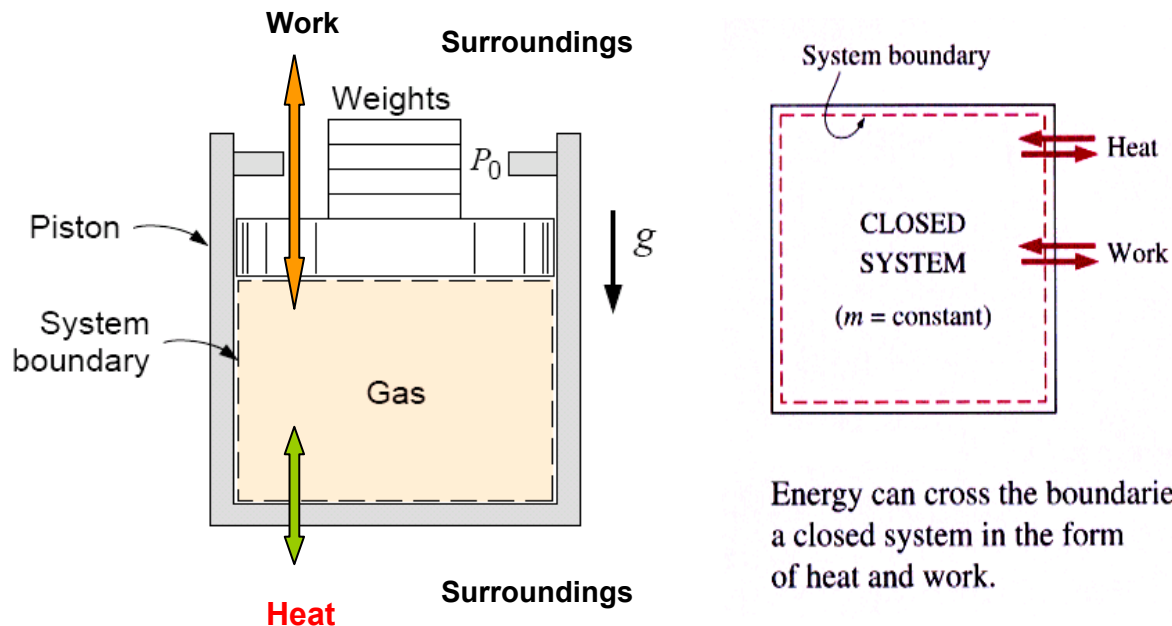

Energy can cross the boundaries of a closed system in the form of heat and work.

our living.

Energy Transfer across the system boundary by Work and Heat

WORK

Work is said to be done when force acting upon a body moves through a distance in the direction of the force. If part of the boundary of a system undergoes a displacement under the action of a pressure, the work done, W , is the product of the force (pressure \times area), and the distance it moves in the direction of the force.

The basic unit of work is Newton metre (Nm), and also called the joule (J). Work is a quantity, which is not a property of a system. It is a transient quantity, which only appears at the boundary while a change of state taking place within a system.

Hence, **work is 'something' which appears at the boundary when a system changes its state due to movement of a part of the boundary under the action of force.** Another definition is: **work is said to be done by a system if the sole effect on things external to the system can be reduced to raising of weight.**

Examples of Work

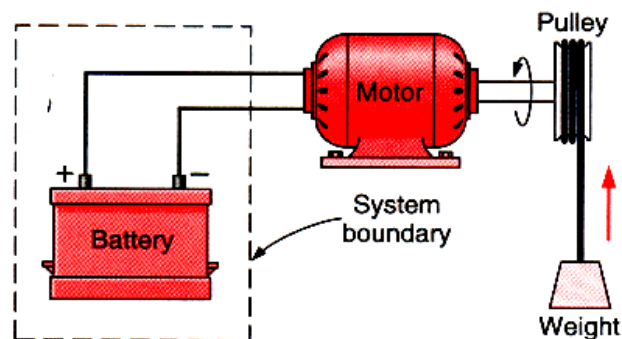
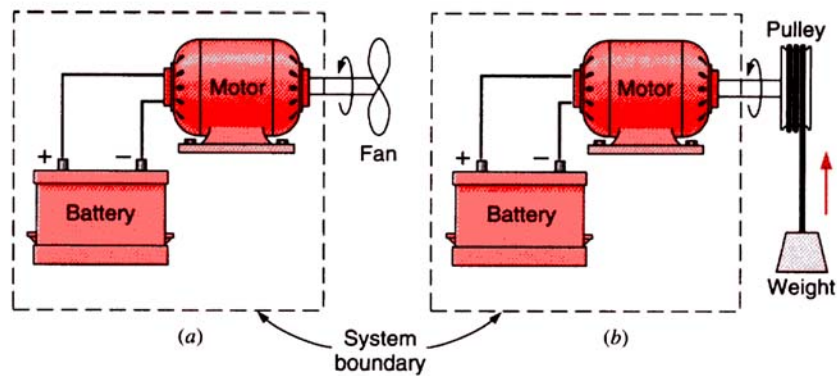

Work crossing the system boundary whose sole effect on the surroundings could be raising of a weight

Various types of Work

(i) *pdV- work or Displacement work*

Let us consider a closed system where a part of the boundary is allowed to move under such conditions that the external restraining force is infinitesimally smaller than the force produced by the pressure of the system. The area of the piston is A and the pressure of the fluid at any instant is p . If p is assumed to be constant during an infinitesimal movement of the piston over a distance dl , the work done by the fluid in moving the external force pA through this distance is $pA dl$. But $A \cdot dl$ is dV , the infinitesimal change of volume, therefore

$$dW = p dV$$

If the expansion occurs from pressure p_1 to a pressure p_2 in such a way that the restraining force is changed continuously, then the total work done can be found out by summing up all the increments of work $p dV$, i.e.

$$W = \int_1^2 p dV$$

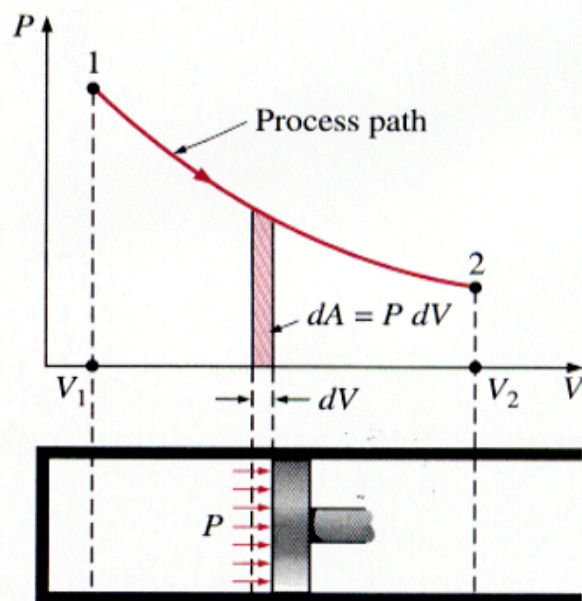

The area under the process curve on a P - V diagram represents the boundary work.

(ii) **Electrical work**

When a current flows through a resistor taken as a system, there is work transfer into the system. This is because current drives the motor, the motor can drive a pulley and the pulley can raise the weight.

The current flow, I , in amperes is given by

$$I = \frac{dC}{d\tau}$$

where C is the charge in coulombs and τ is time in seconds. Thus dC is the charge crossing a boundary during time $d\tau$. If E is the voltage potential, the work is

$$dW = E \cdot dC = EI \cdot d\tau$$

or
$$W = \int_1^2 EI d\tau$$

The electrical power will be

$$\dot{W} = EI$$

(iii) Shaft work

If T is the torque applied to the shaft and $d\theta$ is the angular displacement, the shaft work is

$$W = \int_1^2 T d\theta$$

and the shaft work is

$$\dot{W} = \int T \frac{d\theta}{d\tau} = T \omega$$

where ω is the angular velocity.

HEAT

Heat is 'something' which appears at the boundary when a system changes its state due to temperature difference between the system and surroundings. It is denoted by Q and the unit of heat is joule (J).

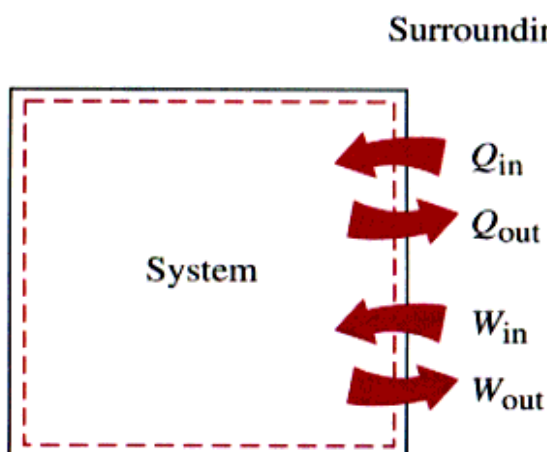

Sign Convention for Heat and Work

Work done by the system on the surroundings is positive; work done on the system by the surroundings is negative.

Heat flow into the system from the surroundings is positive and heat flow from the system to the surroundings is negative.

Hence,

Q_{in} is taken as positive.

W_{out} is taken as positive.

PATH FUNCTION AND POINT FUNCTION

From Fig. it can be seen that a system can be taken from state 1 to state 2 along many quasi-static paths, such as A, B or C. Since the area under each curve represents the work for each process, the amount of work involved in each case is not a function of the end states of the process, and it depends on the path of the system follows in going from state 1 to state 2. For this reason, work is called a path function and dW is an inexact or imperfect differential.

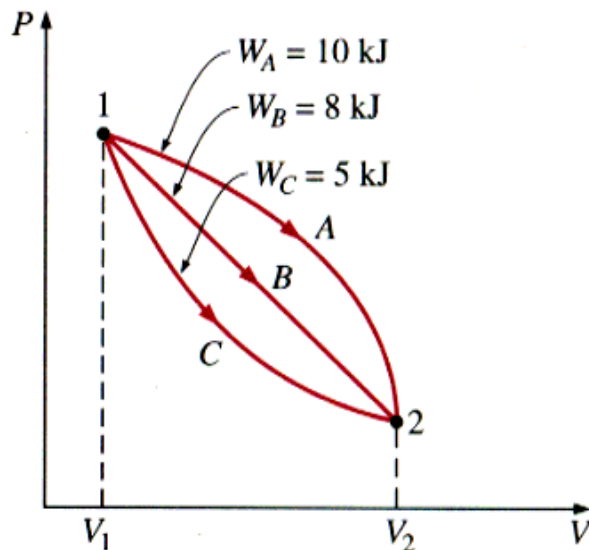

Thermodynamic properties are point functions, since for a given state; there is a definite value for each property. The change in thermodynamic property of any system in a change of state is independent of path of the system follows during the change of state, and only depends on the initial and final states of the system. The differentials of point functions are exact or perfect differentials and integration is simply

$$\int_1^2 dV = V_2 - V_1$$

However,

$$\int_1^2 dW \neq W_2 - W_1$$

Rather

$$\int_1^2 dW = {}_1W_2 \text{ or } W_{1-2}$$

Work , heat and reversibility

Let us consider a closed system where a part of the boundary is allowed to move under such conditions that the external restraining force is infinitesimally smaller than the force produced by the pressure of the system. The area of the piston is A and the pressure of the fluid at any instant is p . If p is assumed to be constant during an infinitesimal movement of the piston over a distance dl , the work done by the fluid in moving the external force pA through this distance is $pA dl$. But $A dl$ is dV , the infinitesimal change of volume, therefore

$$dW = p dV$$

If the expansion occurs from pressure p_1 to a pressure p_2 in such a way that the restraining force is changed continuously, then the total work done can be found out by summing up all the increments of work $p dV$, i.e.

$$W = \int_1^2 p dV$$

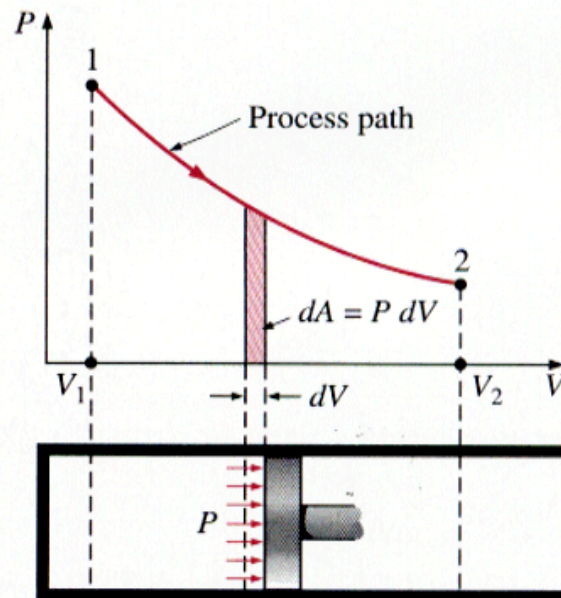

The area under the process curve on a P - V diagram represents the boundary work.

The condition under which this expansion has been imagined to proceed is just those necessary for the expansion to be reversible. There are no pressure gradients and the properties are uniform throughout the system at all the times. The system passes through a series of equilibrium states and the process may be represented by a full line on the p - v diagram. The area under the curve is given by $\int_1^2 p \, dV$ and it represents the work done per unit mass of fluid.

It may be noted that $\int p \, dV$ is not always equal to the work done per unit mass, and the equality only holds when the system passes through a series of equilibrium states.

Consider a container divided into two compartments by a sliding partition. One part contains a mass of gas at a pressure p_1 and specific volume v_1 and the other is

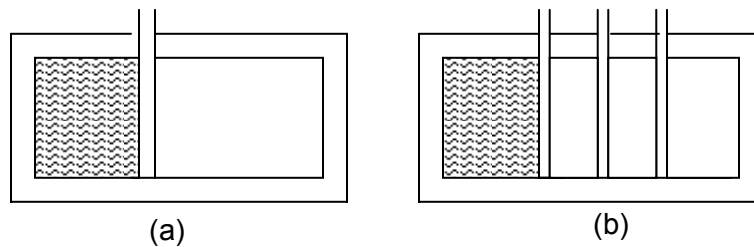

Free expansion

evacuated. When the partition is withdrawn, the gas undergoes free expansion and settles down to a new equilibrium state with pressure p_2 and specific volume v_2 .

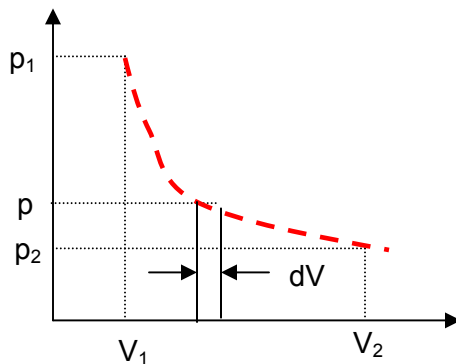

Irreversible process

The intermediate states are indeterminate because no single values of p and v can be ascribed to the system as a whole. The end states could be located in the p - v diagram, but the process could be indicated only by dotted lines. By having several partitions, some intermediate pressures and specific volumes could be measured and the corresponding state points plotted in the p - v diagram. If a dotted

curve is drawn through all such points, the area under the curve would be equal to

$\int_1^2 p \, dV$. Yet no work has been done by the system on the surroundings at all because

no external force has been moved through a distance.

Thus it implies that the reversible expansion or compression is an infinitely slow process. Since any real process must occur within a finite time, it is clear that the reversible process is an ideal process.

Similarly, it can be shown that the transfer of energy due to the temperature difference can only be carried out reversibly if the temperature difference is infinitesimally small. This implies that the rate at which the transfer can proceed is infinitely slow.

Similarities between Heat and Work

1. Heat & work are phenomena that occur at the system boundary.
2. The system does not possess heat & work; it only possesses energy.
3. The consequence of heat & work crossing the system boundary is to change the system state or its energy content.
4. Both heat and work are path dependent phenomena

Summary

Neither heat nor work are properties of a system, but both are **transient quantities**, only appearing at the boundary while a change in state occurs within the system. Although they cannot be used to describe the state of a system, heat and work can be used to describe the process undergone by the system during the change of state. Heat and work are not only functions of the initial and final state of the system, but also of the process undergone by the system.

First Law of Thermodynamics of a Closed System.

The structure of thermodynamics rests upon two fundamental laws. The First law, which will be introduced here, is concerned with the principle of conservation of energy as

applied to a closed system, which undergo changes of state due to transfers of work and heat across the boundary. The First law cannot be proved; its validity rests upon the fact that neither it nor its consequences have ever been contradicted.

THE CYCLE

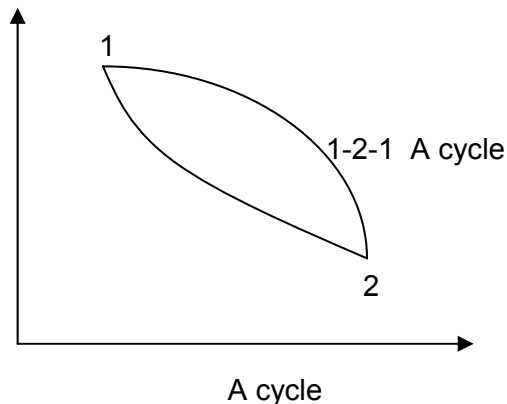

A closed system is said to undergo a cyclic process, or **cycle**, when it passes through a series of states in such a way that its final state is equal in all respect to its initial state.

This implies that all its properties have regained their initial values. The system is then in a position to be put through the same cycles of events again, and the procedure

may be repeated indefinitely.

FIRST LAW OF THERMODYNAMICS FOR A CLOSED SYSTEM

When any closed system is taken through a cycle, the net work delivered to the surroundings is proportional to the net heat taken from the surroundings. This may be expressed as

$$(\sum \delta Q)_{\text{cycle}} \propto (\sum \delta W)_{\text{cycle}}$$

or

$$(\sum \delta Q)_{\text{cycle}} = J (\sum \delta W)_{\text{cycle}}$$

J is called the **mechanical equivalent of heat** or **Joule's equivalent**; it expresses the number of work units, which are equivalent to one unit. For SI unit the value of J is unity. If kJ and kcal are chosen as the units of work and heat respectively, then the value of J is 4.19 kJ/kcal. Hence, J can be dropped from above equation, which now can be written as

$$(\sum \delta Q)_{\text{cycle}} - (\sum \delta W)_{\text{cycle}} = 0$$

FIRST LAW OF THERMODYNAMICS FOR A CHANGE OF STATE

The expression $(\sum \delta Q)_{\text{cycle}} = (\sum \delta W)_{\text{cycle}}$ applies to a system undergoing a cycle. But if the system undergoes a change of state during which both heat and work transfers are involved, the net energy transfer will be stored or accumulated within the system. If Q is the amount of heat transferred to the system and W is the amount of work transferred from the system during the process, the net energy transfer $(Q-W)$ will be stored in the system. This stored energy is known as internal energy or simply energy of the system. Hence, the First Law for a change of state is the net energy transfer during a process involving heat and work transfers is equal to the change in increase in energy of the system.

That is

$$Q - W = \Delta E$$

ENERGY IS A PROPERTY OF THE SYSTEM

Proof: Consider a system which changes its state from state 1 to state 2., following the path A and returns from state 2 to state 1 following path B. So the system undergoes a cycle.

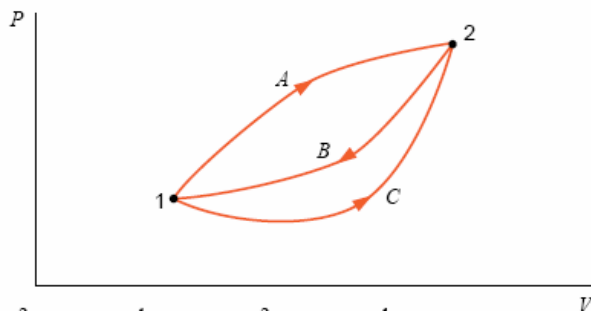

Hence,

$$Q_A = W_A + \Delta E_A$$

$$\text{and } Q_B = W_B + \Delta E_B$$

The process A and B together forms a cycle and hence

$$Q_A + Q_B = W_A + W_B$$

$$\text{or } Q_A - W_A = W_B - Q_B = - (Q_B - W_B)$$

$$\text{or } \Delta E_A = -\Delta E_B$$

Similarly if the system returns from state 2 to state 1 following path C instead of path B then

$$\Delta E_A = -\Delta E_C$$

$$\text{Hence, } \Delta E_B = \Delta E_C$$

That is the change in energy between the two states of a system is same and independent of path followed by the system. Therefore energy has a definite value for every state of the system. Hence, it is a point function and a property of the system.

Different forms of energy

The symbol E refers to the total energy of the system. Basically there are two modes in which the energy may be stored in the system:

- Macroscopic energy mode;
- Microscope energy mode.

Macroscopic energy mode includes kinetic energy and potential energy of the system.

$$\text{Kinetic energy, } E_K = \frac{m V^2}{2}$$

$$\text{Potential energy, } E_P = mgZ$$

Where, m is the mass, V is the velocity and Z is the elevation of the system.

Microscopic energy mode refers to the energy stored in the molecular and atomic structure of the system, which is called internal energy, denoted by U.

$$\text{Hence, } E = E_K + E_P + U$$

For a closed system $E_K = 0$ and E_P also can be assumed to be zero.

$$\text{Hence, for a closed system } E = U$$

$$\text{and } Q - W = \Delta U = U_2 - U_1$$

$$\text{or } dQ - dW = dU$$

COROLLARIES OF THE FIRST LAW

Corollary 1. *There exists a property of a closed system such that a change in its value is equal to the difference between the heat supplied and the work done during any change of state.*

If the property is denoted by U, the corollary can be expressed as

$$\sum_1^2 (\delta Q - \delta W) = U_2 - U_1$$

or $Q - W = U_2 - U_1$

where Q and W are the net quantities of heat and work crossing the boundary during the change of state. The property U is called the internal energy of the system and equation is called the **non-flow energy equation**.

The internal energy, U , is sum of microscopic energy due to

- Molecular level – translation, rotation, vibration
- Chemical reaction – bond energy (heat of formation)
- Dissociation – ion energy
- Atomic – nuclear energy

Internal energy is a thermodynamic property and hence it is a State function and independent of process. If two independent properties are given, U is uniquely determined.

Corollary 2. *The internal energy of a closed system remains unchanged if the system is isolated from its surroundings.*

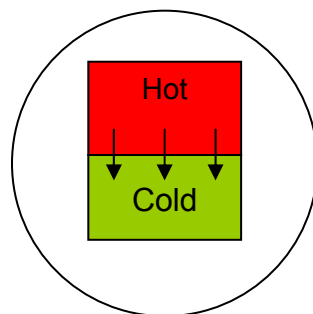

Isolated system

Boundary

If the system is isolated from the surroundings, Q and W are both zero and hence, ΔU must be zero. The system represented in Fig. below is an example of an isolated system. All that happens in this case is a spontaneous redistribution of energy between parts of the system, which continues until a state of equilibrium is reached; there is no change in the

total quantity of energy within the system during the process. Corollary 2 is often called the Law of Conservation of Energy.

Corollary 3. *A perpetual motion machine of the first kind (PMM I) is impossible.*

Definition: **PMM1 is a device which delivers work continuously without any energy input.**

The perpetual machine was originally conceived as a purely mechanical contrivance which, when once set in motion, would continue to run forever. Existence of such a machine is impossible because of the presence of friction. What would be immense value is a machine producing a continuous supply of work without absorbing energy from the surroundings.

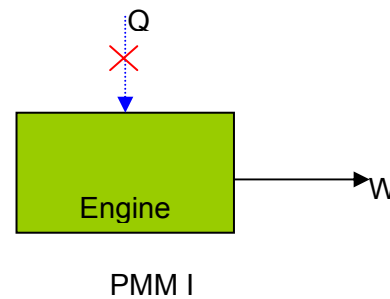

It is always possible to devise a machine to deliver a limited quantity of work without a source of energy in the surroundings. For example, a gas compressed behind a piston will expand and do the work at the expense of internal energy of the gas. Such a device cannot produce work continuously and for this to happen the machine must be capable of undergoing a succession of cyclic process. But as per First Law no net amount of work can be delivered by the system if a net amount of heat is not supplied by the surroundings during a cycle. Thus the First law implies that a perpetual machine of first kind is impossible.

THE ENERGY EQUATION AND REVERSIBILITY

The energy equation for the non-flow process can be written as

$$Q - W = U_2 - U_1$$

When the system is in equilibrium all the properties are uniform throughout the system and each unit mass of the system will have same internal energy. Thus if u represents the internal energy per unit mass of the system, then it is possible to write $U = mu$. u is termed as *specific internal energy*. It is often convenient to work with the specific quantities throughout an analysis and then multiply the final result by the mass of the system. Thus the non-flow energy equation is usually written as

$$Q - W = u_2 - u_1$$

implying that Q and W are the quantities of heat and work per unit mass.

For a reversible process, the system is imagined to pass through a continuous series of equilibrium states. In such cases the equation may be applied to any infinitesimal part of the process between the end state, and the energy equation can be written as

$$dQ - dW = du$$

For irreversible process the system does not pass through a series of equilibrium states. Hence, it is not possible to write mu for the internal energy of the system in any intermediate state. Each elemental mass δm may have a different specific internal energy e , which may include kinetic and potential energy of the mass δm . When considering the irreversible processes, the energy equation can only be used in the integrated form and it is then sufficient to be able to assign the values of u to the end states.

CONSTANT VOLUME PROCESS

For a constant volume process, work can only be done by some method of churning the liquid. There cannot be any $\int p dV$ work as no external force has been moved through a distance. Hence, W must be zero or negative. For a constant volume process, unless otherwise stated, work done is taken as zero. Thus energy equation for a constant volume process is usually written as

$$Q = u_2 - u_1$$

If, in addition to work being zero, it is stipulated that the heat is transferred by virtue of an infinitesimally small temperature difference, then the process is reversible and the equation can be written in differential form as

$$dQ = du$$

CONSTANT PRESSURE PROCESS

A closed system undergoing at constant process is shown in Fig. The fluid is enclosed in a cylinder by a piston on which rests a constant weight. If heat is supplied, the fluid expands and work is being done by the system in overcoming the constant force; if the heat is extracted,

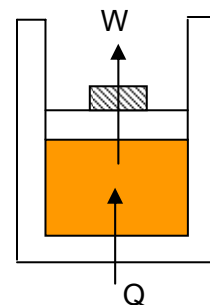

the fluid contracts and work is done on the system by the constant force. In the general case

$$Q - W = (u_2 - u_1)$$

If no paddle work is done on the system, and the process is reversible,

$$dQ - p \, dv = du$$

Since p is constant, this can be integrated to give

$$Q - p (v_2 - v_1) = (u_2 - u_1)$$

A further simplification is for constant pressure process if a new property is introduced. Since p is constant, $p \, dv$ is identical to $d(pv)$. Thus energy equation becomes

$$dQ - d(pv) = du$$

or
$$dQ = d(u + pv) = dh$$

where $h = u + pv$, known as enthalpy. Since enthalpy is a combination of properties u , p and v , it itself is a property. Hence

$$h = u + pv$$

and for any mass of fluid m , in a state of equilibrium

$$H = U + pV$$

Using this derived property, the energy equation for a reversible constant pressure process becomes

$$dQ = dh$$

or in the integrated form

$$Q = (h_2 - h_1)$$

Thus heat added in a reversible constant pressure process is equal to increase of enthalpy, whereas it is equal to increase of internal energy in the reversible constant volume process.

SPECIFIC HEAT

The specific heat at constant volume C_V is defined as the rate of change of specific internal energy with respect to temperature when volume is held constant, i.e.

$$C_V = \left(\frac{\partial u}{\partial T} \right)_V$$

For constant volume process

$$\Delta u = C_V \Delta T$$

For a closed system with constant volume process

$$Q = \Delta u = C_V \Delta T$$

The specific heat at constant pressure C_P is defined as the rate of change of specific enthalpy with respect to temperature when pressure is held constant, i.e.

$$C_P = \left(\frac{\partial h}{\partial T} \right)_P$$

For constant pressure process

$$\Delta h = C_P \Delta T$$

For a closed system with constant pressure process

$$Q = \Delta h = C_P \Delta T$$

For a perfect gas $u = f(T)$

Hence, $du = C_V dT$ or $u_2 - u_1 = C_V (T_2 - T_1)$

$$h = u + pv$$

$$= u + RT$$

or $dh = du + R dT = C_V dT + R dT = (C_V + R) dT$

Now, $dh = C_P dT$ (this is true only for a perfect gas)

Hence, $C_P = C_V + R$

Also, $\frac{C_P}{C_V} = \gamma$

For air: $C_p = 1.005 \text{ kJ/kg K}$

$C_v = 0.718 \text{ kJ/kg K}$

$R = 0.287 \text{ kJ/kg K}$

$\gamma = 1.4$

PROCESS IN WHICH $p v = \text{constant}$

$$W_{1-2} = \int_1^2 p \, dV$$

Now $p v = p_1 v_1 = c$ or $p = \frac{p_1 v_1}{v}$

$$\therefore {}_1W_2 = \int_1^2 \frac{p_1 v_1}{v} \, dv = p_1 v_1 \int_1^2 \frac{dv}{v} = p_1 v_1 \ln \frac{v_2}{v_1}$$

$$\therefore {}_1W_2 = p_1 v_1 \ln \frac{v_2}{v_1} = p_1 v_1 \ln \frac{p_1}{p_2}$$

POLYTROPIC PROCESS

The constant volume and constant pressure processes can be regarded as limiting cases of a more general type of processes in which both volume and pressure change in a certain specified way. In many real processes, it is found that the states during expansion or compression can be expressed as $p v^n = \text{constant}$, where n is a constant called the index of expansion or compression and p and v are average values of pressure and specific volume for the system. This is called *Polytropic process*. When $n=0$ the relation reduce to $p = \text{constant}$ and when $n = \infty$ it reduces to $v = \text{constant}$.

Isobaric process: $P = \text{const}$, $n = 0$
Isothermal process: $T = \text{const}$, $n = 1$
Isometric process: $v = \text{const}$, $n = \infty$;
Isentropic process: $s = \text{const}$, $n = k$

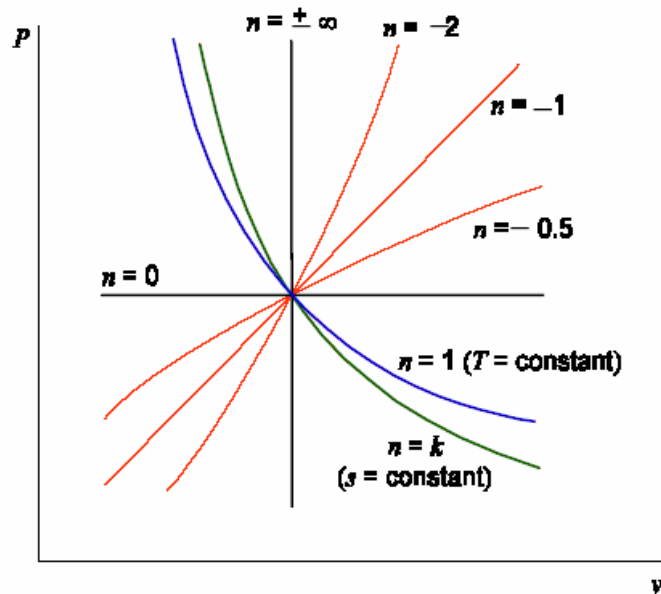

For the reversible Polytropic process, single values of p and v can truly define the state of a system, and $dW = p dv$. For any intermediate state

$$p_1 v_1^n = p_2 v_2^n = p v^n$$

Therefore

$$\begin{aligned}
 W &= \int_1^2 p dv = p_1 v_1^n \int_1^2 \frac{dv}{v^n} = \frac{p_1 v_1^n (v_2^{1-n} - v_1^{1-n})}{1-n} = \frac{p_2 v_2^n v_2^{1-n} - p_1 v_1^n v_1^{1-n}}{1-n} \\
 &= \frac{p_2 v_2 - p_1 v_1}{1-n} = \frac{p_1 v_1}{n-1} \left[1 - \left(\frac{p_2}{p_1} \right)^{n-1/n} \right]
 \end{aligned}$$

The integrated form of energy equation for a reversible polytropic process may therefore be written as

$$Q - \frac{p_2 v_2 - p_1 v_1}{1-n} = (u_2 - u_1)$$

Relation between p,v,T

$$pv = RT$$

$$\frac{p_1 v_1}{T_1} = \frac{p_2 v_2}{T_2} \quad \text{or} \quad \frac{T_2}{T_1} = \frac{p_2 v_2}{p_1 v_1}$$

$$\text{Now } p_1 v_1^n = p_2 v_2^n \quad \text{or} \quad \frac{v_2}{v_1} = \left(\frac{p_2}{p_1} \right)^{\frac{1}{n}}$$

$$\therefore \frac{T_2}{T_1} = \left(\frac{p_2}{p_1} \right)^{\frac{n-1}{n}} = \left(\frac{v_2}{v_1} \right)^{1-n}$$

Reversible Adiabatic Process (Isentropic Process)

The term **adiabatic** is used to describe any process during which heat is prevented from crossing the boundary of the system. That is, an adiabatic process is one undergone by a system, which is thermally insulated from its surroundings. For adiabatic non-flow processes, the energy equation reduces to

$$-W = (u_2 - u_1)$$

From First Law

$$Q = du + W$$

For adiabatic process, this becomes

$$0 = C_V dT + p dv$$

Also $pv = RT$ (equation of state)

$$\text{or } p dv + v dp = R dT$$

$$\text{Hence, } \frac{C_V}{R} (p dv + v dp) + p dv = 0 \quad \text{or} \quad \left(\frac{C_V}{R} + 1 \right) p dv + \frac{C_V}{R} v dp = 0$$

$$\text{Now } C_P = C_V + R$$

$$\therefore \frac{C_P}{R} p dv + \frac{C_V}{R} v dp = 0$$

$$\text{or } \frac{C_P}{C_V} \frac{dv}{v} + \frac{dp}{p} = 0$$

Integrating we get

$$\gamma \ln v + \ln p = \text{const}$$

$$\text{or } pv^\gamma = \text{const.}$$

ISOTHERMAL PROCESS

When the quantities of heat and work are so proportioned during a process such that the temperature of the fluid remains constant, the process is said to be ***isothermal***. Since temperature gradients are excluded by definition, the reversibility of the isothermal process is implied.

Recommended Solution Procedure

STEP 1

Sketch the diagram including all mass, heat and work flows, and direction of forces (e.g. external pressures and gravitation).

STEP 2

Define a system. Identify the initial and final states (label them 1 and 2), and write down all the known conditions.

STEP 3

Write the applicable laws for the system.

STEP 4

Determine if the substance can be handled as an ideal gas or by the table.

STEP 5

What do you know about the process? Anything constant or zero? Relationships

between properties?

STEP 6

Find which quantities are known and which are unknown. Determine which two independent properties should be found for any given state. Diagrams are helpful.

STEP 7

Determine the unknown quantities.

First Law applied to Flow Processes

STEADY FLOW ENERGY EQUATION

For any system and in any process, the first law can be written as

$$Q = \Delta E + W$$

Where E represents all forms of stored energy in the system.

For a pure substance

$$E = E_K + E_P + U$$

Where

$$E_K = \text{Kinetic energy} = \frac{m C^2}{2}; \text{ where } C \text{ is the velocity of fluid.}$$

$$E_P = \text{Potential energy} = mgz$$

U is the residual energy (internal energy) stored in the molecular structure of the substance. Hence,

$$Q = \Delta E_K + \Delta E_P + \Delta U + W$$

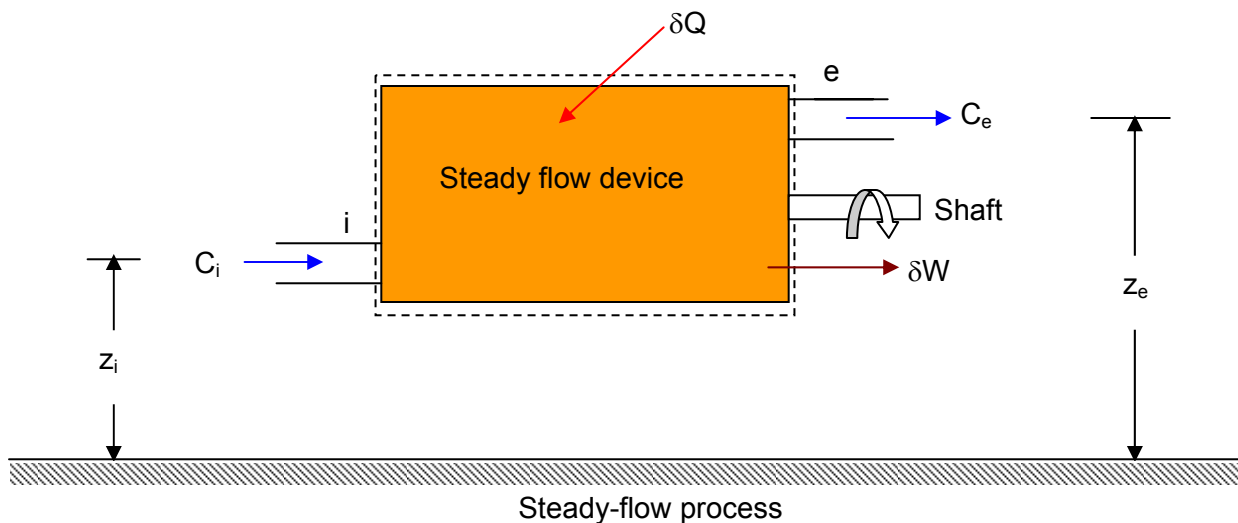

Let

A_i, A_e — Cross sectional area, m^2

W_i, W_e — mass flow rate, kg/s

p_i, p_e — absolute pressure, N/m^2

v_i, v_e — specific volume, m^3/kg

u_i, u_e — specific internal energy, J/kg

C_i, C_e — velocity, m/s

z_i, z_e — elevation from an arbitrary datum level, m

Subscript i and e refers to the inlet and exit sections.

The total energy of mass δm at the inlet is

$$U_i + \frac{1}{2} \delta m C_i^2 + \delta m g z_i \quad \text{or} \quad \delta m \left(u_i + \frac{C_i^2}{2} + g z_i \right)$$

Similarly, the total energy of mass δm at the outlet is

$$\delta m \left(u_e + \frac{C_e^2}{2} + g z_e \right)$$

Lastly we must consider how the system changes its state from i to e. We may assume that δQ units of energy are transferred to the system as heat and that δW units of energy are transferred to the surroundings as work via a turbine shaft. δW is not only

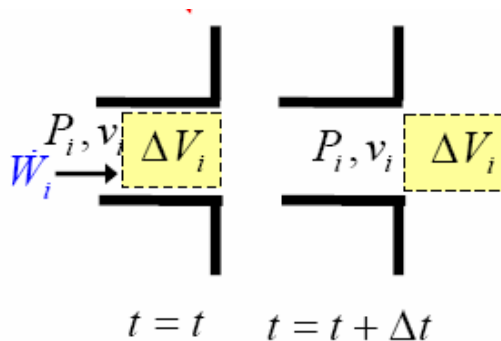

work done so far as the system is concerned because parts of its boundary move at sections i and e. For the element δm to enter the open system, the system must be compressed, its volume decreasing by $\delta m v_i$. This is accompanied by a force $p_i A$ moving a distance $l = \delta m v_i / A$, where A is the cross-

sectional area of the element. The work done by the surroundings on the system is therefore $\delta m p_i v_i$. Similarly it can be shown that the work done by the system to the surroundings is $\delta m p_e v_e$. The net work done by the system during the change is therefore

$$\delta W + \delta m (p_e v_e - p_i v_i)$$

We may now write the energy equation for the open system as

$$\delta Q - \{\delta W + \delta m (p_e v_e - p_i v_i)\} = \delta m \left(u_e + \frac{C_e^2}{2} + g z_e \right) - \delta m \left(u_i + \frac{C_i^2}{2} + g z_i \right)$$

By writing h for $(u + pv)$, the equation becomes

$$\delta Q - \delta W = \delta m \left(h_e + \frac{C_e^2}{2} + z_e \right) - \delta m \left(h_i + \frac{C_i^2}{2} + z_i \right)$$

The continuous steady-flow process consists of the sum total of all the elemental mass transfers across sections 1 and 2. It may therefore be represented as

$$\sum \delta Q - \sum \delta W = \sum \delta m \left(h_e + \frac{C_e^2}{2} + z_e \right) - \sum \delta m \left(h_i + \frac{C_i^2}{2} + z_i \right)$$

If we consider the properties to be uniform over the cross-section of flow at inlet and outlet and write m for $\sum \delta m$ then the above equation becomes after simplifying

$$Q - W = (h_e - h_i) + \frac{1}{2}(C_e^2 - C_i^2) + g(z_e - z_i)$$

where Q and W are the heat and work transfers per unit mass flowing through the system. The assumptions upon which the equation is based may be summarised as follows:

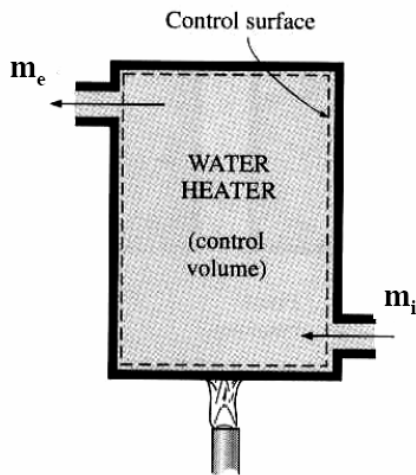

1. The mass flow at the inlet is constant with respect to time, and equal to mass flow at outlet.
2. The properties at any point within the open system do not vary with time.
3. The properties are constant over the cross-section of the flow at inlet and outlet.
4. Any heat or work crossing the boundary does so at a uniform rate.

Finally we must note an important equation which follows directly from assumptions (1) and (3). It is known as the **continuity equation** and expresses the principle of conservation of mass in steady flow. If m is the rate of mass flow, we have

$$m = \frac{A_i C_i}{v_i} = \frac{A_e C_e}{v_e} = \rho_i C_i A_i = \rho_e C_e A_e$$

FIRST LAW AS A RATE EQUATION

It expresses the instantaneous or average rate at which energy crosses the system boundary as heat and work and the rate at which the energy of the system changes.

Conservation of Mass

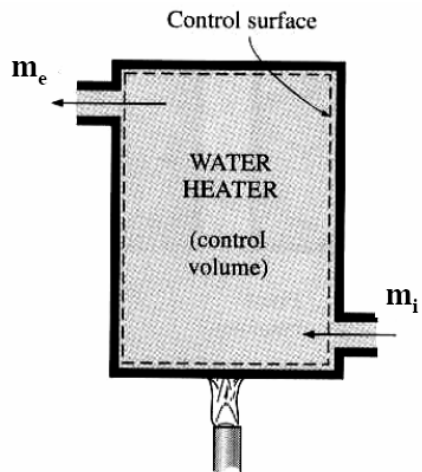

Mass flow in – mass flow out = accumulation in the control volume.

$$\text{i.e. } \delta m_{cv} = m_i - m_e$$

Dividing by δt we get

$$\frac{\delta m_{cv}}{\delta t} = \frac{m_i}{\delta t} - \frac{m_e}{\delta t}$$

$$\text{or } \frac{dm_{cv}}{dt} = m_i - m_e$$

$$\text{where } \frac{\delta m_i}{\delta t} = m_i \quad \text{and} \quad \frac{\delta m_e}{\delta t} = m_e$$

Conservation of Energy

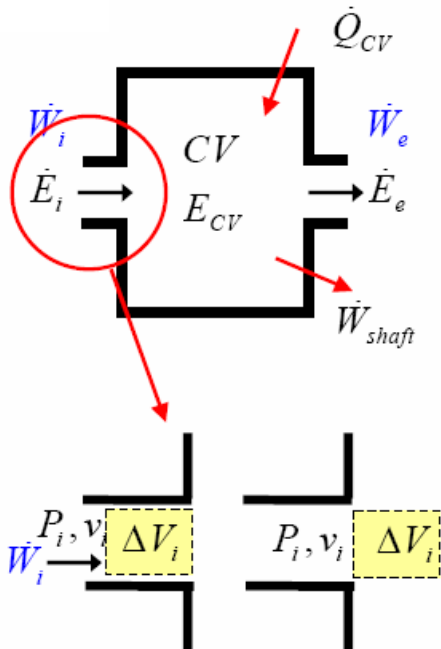

Consider a time interval δt during which an amount of heat δQ crosses the system boundary, an amount of work δW is done by the system, the internal energy change is ΔU , the kinetic energy change is ΔK and potential energy change is ΔPE . Since the mass flow rates at the inlet m_i and outlet m_e are not same, there will be a change of energy stored in the system. If the change in energy stored in the system is ΔE_{cv} , then

First Law states

$$\delta Q = \Delta U + \Delta KE + \Delta PE + \delta W + \Delta E_{cv}$$

Dividing by δt we get

$$\frac{\delta Q}{\delta t} = \frac{\Delta U}{\delta t} + \frac{\Delta KE}{\delta t} + \frac{\Delta PE}{\delta t} + \frac{\delta W}{\delta t} + \frac{\Delta E_{cv}}{\delta t}$$

or $Q = \frac{dU}{dt} + \frac{d(KE)}{dt} + \frac{d(PE)}{dt} + W + \frac{dE_{cv}}{dt}$

where $\frac{\delta Q}{\delta t} = Q$ and $\frac{\delta W}{\delta t} = W$

Hence, the First Law becomes

$$Q + \sum m_i \left(h_i + \frac{C_i^2}{2} + gz_i \right) = \sum m_e \left(h_e + \frac{C_e^2}{2} + gz_e \right) + W + \frac{dE_{cv}}{dt}$$

i.e. $\frac{dE_{cv}}{dt} = Q - W + \sum m_i \left(h_i + \frac{C_i^2}{2} + gz_i \right) - \sum m_e \left(h_e + \frac{C_e^2}{2} + gz_e \right)$

Simplifications

1. Steady State Flow

Fluid properties may vary in space but are constant at each location.

$$m_i \neq m_e ; h_i \neq h_e$$

$$\frac{dE_{cv}}{dt} = 0$$

Hence,

$$0 = Q - W + \sum m_i \left(h_i + \frac{C_i^2}{2} + gz_i \right) - \sum m_e \left(h_e + \frac{C_e^2}{2} + gz_e \right)$$

2. Steady state flow with uniform mass flow rate

Continuity equation becomes

$$m_i = m_e = m$$

$$\therefore Q - W = m(h_e - h_i) + \frac{m}{2}(C_e^2 - C_i^2) + mg(z_e - z_i)$$

3. Negligible KE and PE

$$\dot{Q} - \dot{W} = \dot{m}(h_e - h_i)$$

4. No heat loss, work with negligible KE and PE

$$h_i = h_e$$

Examples of Steady State Devices

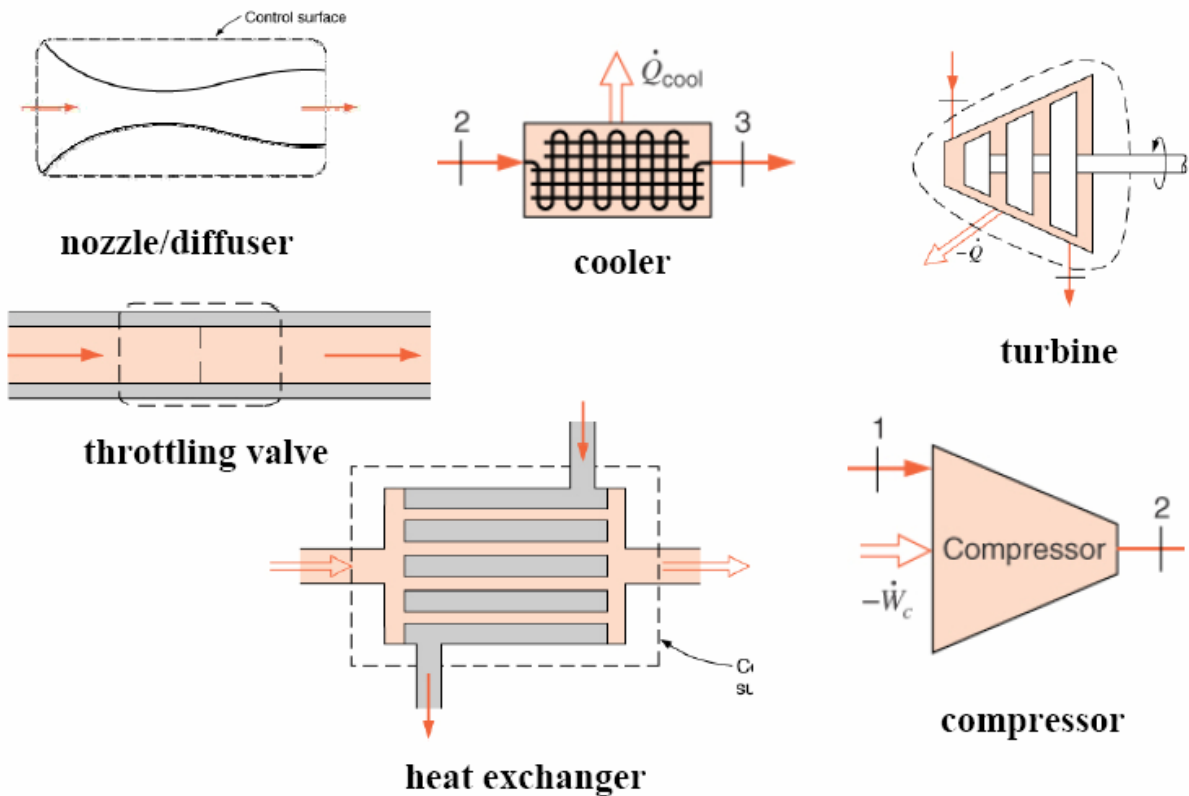

OPEN SYSTEM WITH STEADY FLOW

Boiler

In the boiler, the fluid entering as liquid, leaves as a vapour at a constant rate. In this case no work is done on or by the fluid as it passes through the system. The velocities are usually quite low, so that the difference between kinetic energies at the inlet and outlet is negligible compared to the other terms of the equation.

Assumptions

- Steady ($dE_{CV}/dt = 0$)
- Single inlet/exit
- No shaft work
- KE, PE change negligible (usually)

Hence, Steady Flow Energy Equation (SFEE) becomes

$$Q = h_e - h_i \quad \text{kJ/kg}$$

Nozzles and Diffusers

A nozzle is a duct of varying cross-sectional area so designed that a drop in pressure from inlet to outlet accelerates the flow. The flow through a nozzle usually occurs at a very high speed, and there is little time for the fluid to gain or lose energy by a flow of heat through the walls of the nozzle as the fluid passes through it. The process is therefore always assumed to be adiabatic. Also, no work crosses the boundary during the process. The function of diffuser is the reverse of that of nozzle.

Nozzle – A device to increase velocity at the expense of pressure.

Diffuser – A device to increase pressure at the expense of velocity.

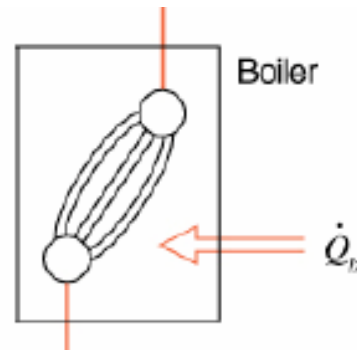

Assumptions

- Steady ($dE_{CV}/dt = 0$)
- Single inlet/exit
- No heat transfer (assuming adiabatic)
- No shaft work
- PE change negligible

Hence, SFEE becomes

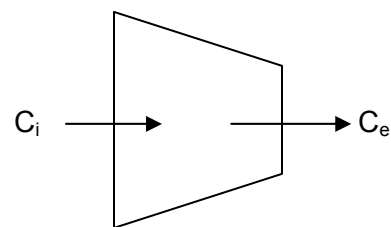

Nozzle, $C_i < C_e$

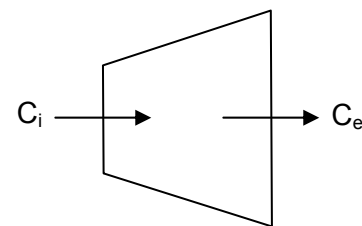

Diffuser, $C_i > C_e$

of

$$h_i + \frac{C_i^2}{2} = h_e + \frac{C_e^2}{2}$$

If $C_e > C_i$ (nozzle) $\Rightarrow h_e < h_i$ (cools down)

If $C_e < C_i$ (diffuser) $\Rightarrow h_e > h_i$ (warms up)

Turbine/Compressor

A turbine is a means of extracting work from a flow of fluid expanding from a high pressure to a low pressure. The fluid is accelerated in a set of fixed nozzles and the resulting high-speed jets of fluid then change their direction as they pass over a row of curved blades attached to the rotor. As first approximation, the velocity at the inlet and outlet of the turbine can be assumed equal. Since the velocity of flow through the turbine is very high, the process can be assumed to be adiabatic. The rotary compressor can be regarded as a reverse turbine, work being done on the fluid to raise the pressure.

Assumptions

- Steady ($dE_{CV}/dt = 0$)
- Single inlet/exit
- No heat transfer (usually, but not always)
- KE, PE change negligible (usually)

Hence, SFFF becomes

$$W = h_i - h_e \quad \text{kJ/kg}$$

Throttling Valves

A flow-restricting device that causes a significant pressure drop accompanied by a large drop in Temperature (valves, porous plug, capillary tubes in refrigerators). The term throttling is usually applied to relatively low-speed flow, i.e. low enough for any

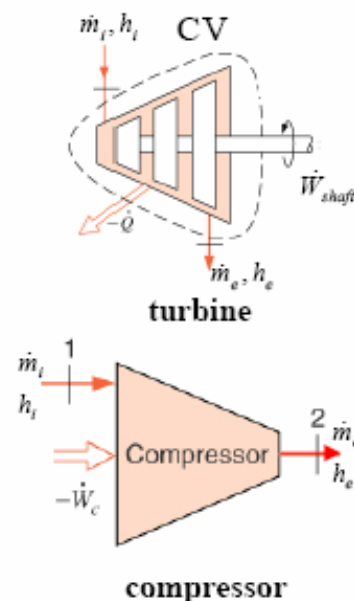

difference between the kinetic energy at the inlet and outlet to be negligible. Any heat transfer across the boundary can be neglected. Also no work crosses the boundary.

Assumptions

- Steady ($dE_{CV}/dt = 0$)
- Single inlet/exit
- No heat transfer and shaft work
- KE, PE change negligible

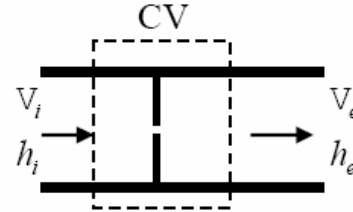

Hence, SFFF becomes

$$h_i = h_e \quad \text{kJ/kg}$$

$$u_i + p_i v_i = u_e + p_e v_e$$

Hence, pv increases at the expense of u (temperature drops)

For real gases, $h = h(T)$ only, i.e. $T_i = T_e$

Heat Exchangers

Consider a double-tube type heat exchanger (tube and shell). In heat exchanger, the change in potential energy and kinetic energy terms are very small and can be neglected. Also, there is no external work.

Assumptions

- Steady ($dE_{CV}/dt = 0$)
- Multiple inlets/exits
- No heat transfer and shaft work
- KE, PE change negligible

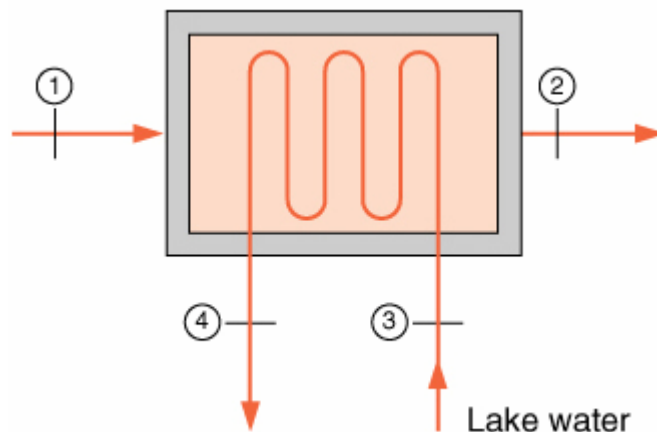

Hence, SFEE becomes

$$\sum_i m_i h_i = \sum_e m_e h_e$$

$$\text{or} \quad m_1 h_1 + m_3 h_3 = m_2 h_2 + m_4 h_4$$

Power Plant

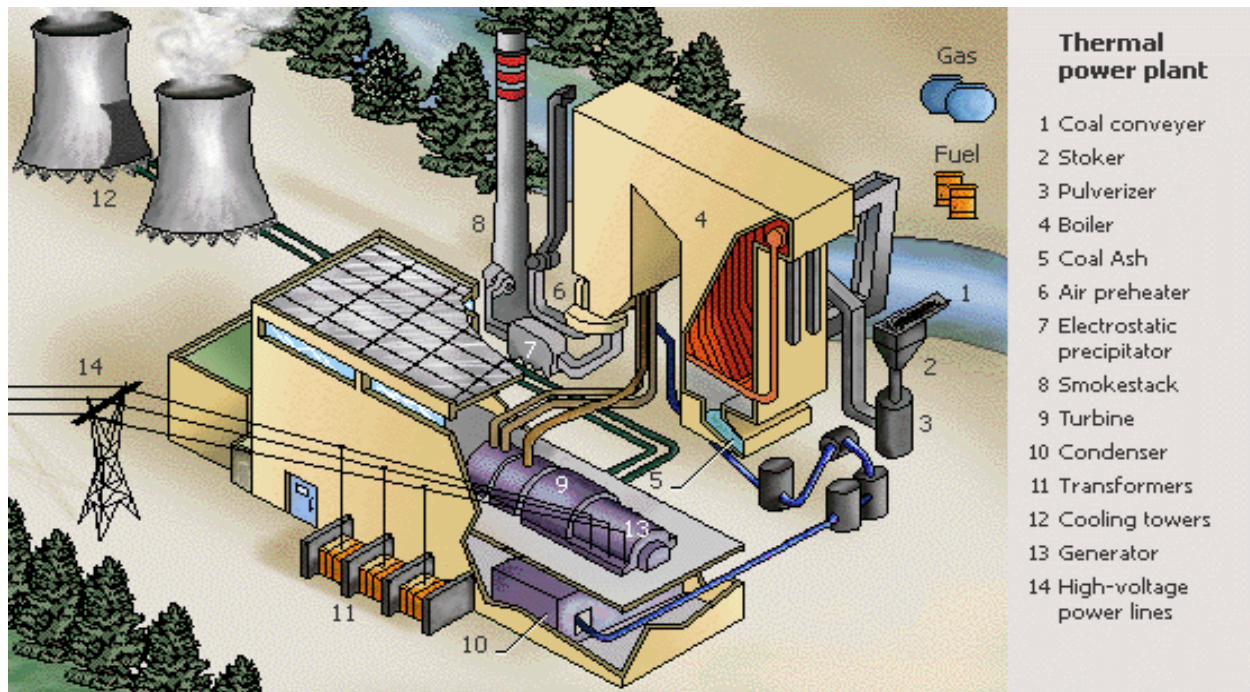

Boiler: $Q_b = {}_1Q_2 = m(h_1 - h_5) = m(h_2 - h_5), \text{ since } h_1 = h_2$

Turbine: $W_T = -{}_2W_3 = m(h_3 - h_2)$

Condenser: $-Q_C = {}_3Q_4 = m(h_4 - h_3)$

Pump: $-W_P = -{}_4W_5 = m(h_5 - h_4)$

Adding we have

$${}_1Q_2 + {}_3Q_4 - {}_2W_3 - {}_4W_5 = 0$$

or $\sum \delta Q - \sum \delta W = 0$

CHAPTER 2 Second Law Entropy and Availability

In this chapter the idea of cycle efficiency is introduced and the Second Law is then stated and distinguished from the First Law. Formal definition of a reversible process is made and its implications both for non-flow and steady-flow processes are discussed.

CYCLE EFFICIENCY

When a closed system undergoes a series of non-flow processes, during which the fluid passes through a cycle of thermodynamic states, the First Law can be expressed as

$$\sum \delta Q = \sum \delta W$$

If Q_1 is the heat supplied, Q_2 the heat rejected and W the net work done by the system during the cycle, the First Law becomes

$$Q_1 - Q_2 = W \quad (6.1)$$

A system operating in a cycle and producing a net quantity of work from a supply of heat is called a *heat engine*. The greater the proportion of the heat supply converted into work, the better the engine is. Consequently the *cycle efficiency* of a heat engine is defined as

$$\eta = \frac{\text{workdone}}{\text{heat supplied}} = \frac{W}{Q_1} \quad (6.2)$$

Hence, from equations (6.1) and (6.2), we have

$$\eta = \frac{Q_1 - Q_2}{Q_1} \quad (6.3)$$

The efficiency of any heat engine operating on either a closed system or an open cycle, consisting of steady-flow processes, can also be expressed by equation (6.3). In this case Q_1 and Q_2 must be interpreted either as the heat supplied and rejected per unit mass flowing round the circuit, or as the rates of heat supplied and rejected.

THE SECOND LAW OF THERMODYNAMICS

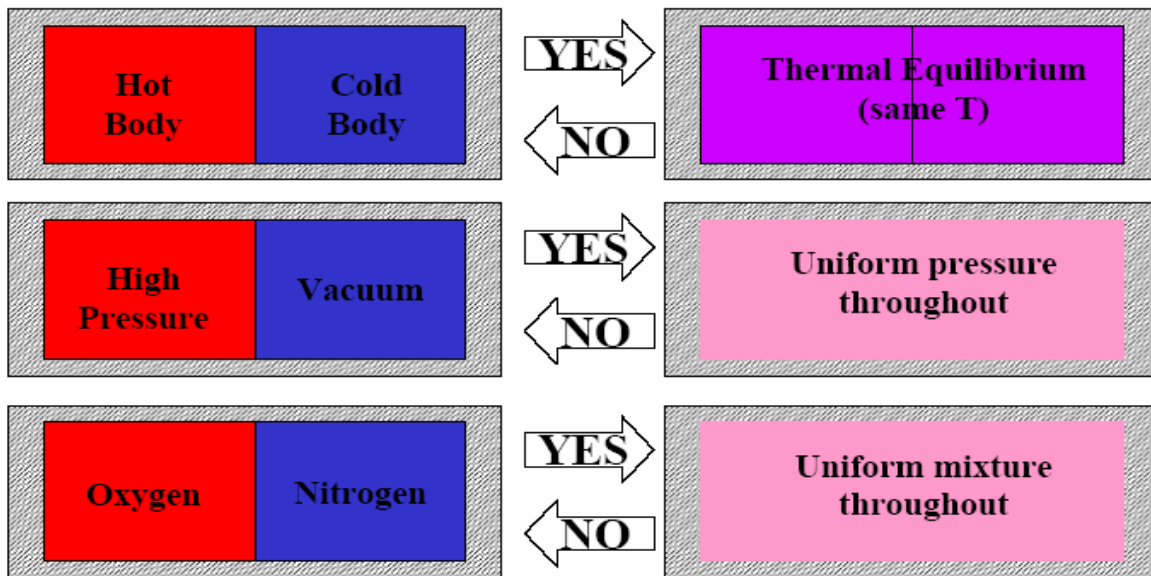

Consider the following isolated systems with well-defined initial states:

We have never observed the reverse to occur, but it does not violate the 1st Law. However, there is a directionality of a process. You can make the reverse happen, but it does not occur SPONTANEOUSLY.

More observations

The direction of spontaneous change for a ball bouncing on a floor. On each bounce

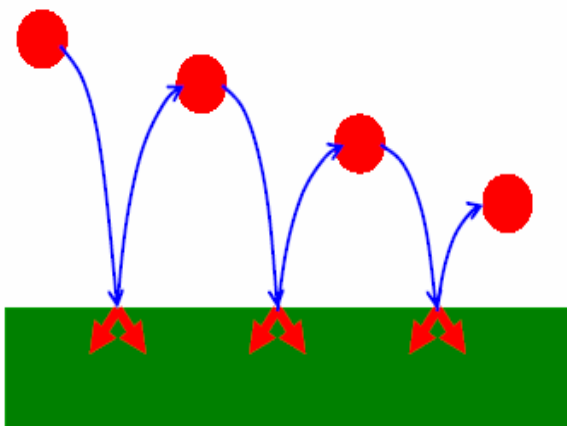

some of its potential energy is degraded into the thermal motion of the atoms of the floor, and that energy disperses into the atoms of the floor. The reverse has never been observed to take place.

The reverse, if it occurs, does not violate the 1st Law as long as the energy is conserved. Recall also that only a small amount of thermal energy is required to make the ball jump very high.

Hence, the first Law only states that the net work cannot be produced during a cycle without some supply of heat. However, First Law never says that some proportions of heat supplied to an engine must be rejected. Hence, as per the First Law, cycle efficiency can be unity, which is impossible in practice. All that First Law states that net work cannot be produced during a cycle without some supply of heat, i.e. that a perpetual motion machine of the first kind is impossible. So, the 1st Law is not enough. Something is missing! What is missing? A law that can tell us about the direction of spontaneous change. The Second Law of Thermodynamics tells us about the directionality of the process. We need it to ensure that systems we design will work. As we will see later, ENTROPY is a property that we have invented (like internal energy) that will allow us to apply the 2nd Law quantitatively.

HEAT ENGINE, HEAT PUMP, REFRIGERATOR

Energy reservoirs: Thermal energy reservoirs (TER) is defined as a large body of infinite

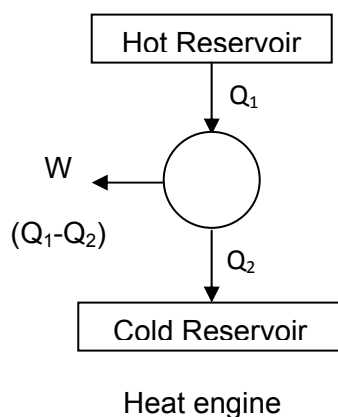

heat capacity, which is capable of absorbing or rejecting an unlimited quantity of heat without suffering appreciable changes in its thermodynamic coordinates.

Source: TER from which heat is transferred to the system operating in a heat engine cycle.

Sink: TER in which heat is rejected from the cycle during a cycle.

Heat Engine cycle is a thermodynamic cycle in which there is a net heat transfer to the system and a net work transfer from the system. The system, which operates in heat engine cycle is called heat engine.

$$\text{Efficiency, } \eta = \frac{\text{workdone (Energy we want)}}{\text{heat supplied (Energy we pay)}} = \frac{W}{Q_1} = \frac{Q_1 - Q_2}{Q_1} = 1 - \frac{Q_2}{Q_1} \leq 1$$

Refrigerator: A device which operating in a cycle maintains a body at a temperature lower than the temperature of the surroundings.

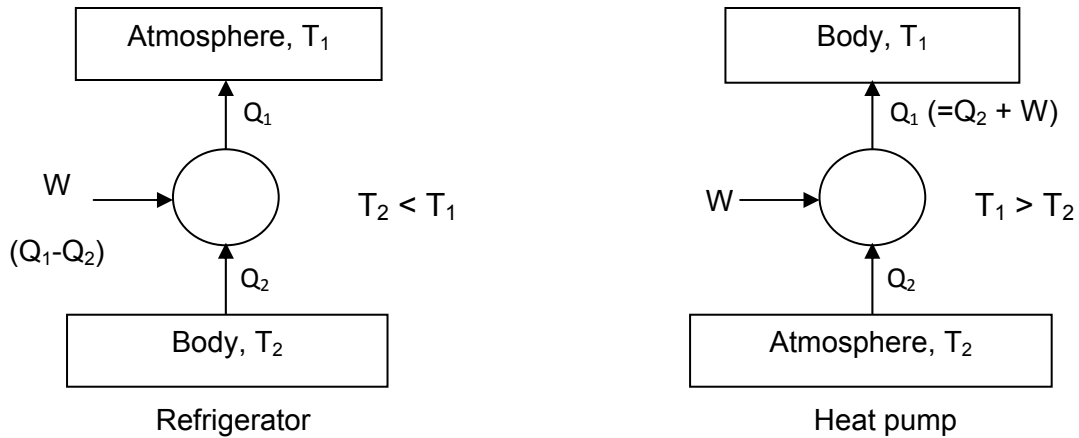

$$\text{COP}_{\text{Ref}} = \frac{Q_2 \text{ (Energy we want)}}{W \text{ (Energy we pay)}} = \frac{Q_2}{Q_1 - Q_2}$$

Heat Pump: A device which operating in a cycle maintains a body at a temperature higher than temperature of surroundings

$$\text{COP}_{\text{HP}} = \frac{Q_1 \text{ (Energy we want)}}{W \text{ (Energy we pay)}} = \frac{Q_1}{Q_1 - Q_2} = \text{COP}_{\text{Ref}} + 1$$

Engineering Examples:

A. System (gas) – undergoes a cycle.

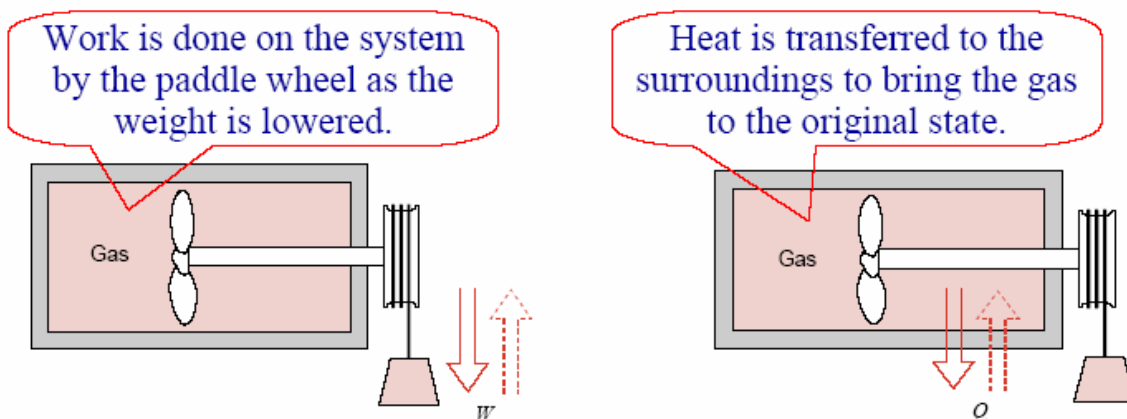

From our experience, the reverse cycle does not occur. $W < 0$ and $Q < 0$ are possible but $W > 0$ and $Q > 0$ are not. However, neither violates the 1st Law.

B. Heat transfer from high T to low T : only one direction is possible, so it is impossible to complete a cycle. This leads us to heat engines and refrigerators – devices that can do the opposite. What are the limitations on these devices?

The Second Law states that some heat must be rejected during the cycle and hence, the cycle efficiency is always less than unity.

Thus the First Law states that net work cannot be greater than heat supplied, while the Second Law goes further and states that it must be less than heat supplied.

If energy is to be supplied to a system in the form of heat, the system must be in contact with a reservoir whose temperature is higher than that of the fluid at some point in the cycle. Similarly, if heat is to be rejected, the system must be at some time be in contact with a reservoir of lower temperature than the fluid. Thus Second Law implies that if a system is to undergo a cycle and produce work, it must operate between two reservoirs of different temperatures. A machine which will work continuously, while exchanging heat with only a single reservoir, is known as a perpetual motion machine of the second kind (**PMM II**); such a machine contradicts Second Law.

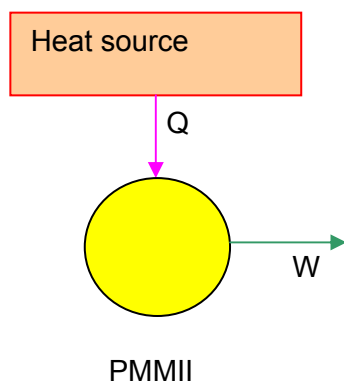

It is now possible to see why a ship could not be driven by an engine using the ocean as a source of heat, or why a power station could not be run using the atmosphere as a source of heat. They are impossible because there is no natural sink of heat at a lower temperature than the atmosphere or ocean, and they would therefore be PMM II.

It should be noted that Second Law does not restrict that work cannot be continuously and completely converted to heat. In fact, a fluid in a closed vessel may have work done on it and the heat thus generated is allowed to cross the boundary. The rates of work and heat may be made equal and the internal energy of the system remaining constant. An important consequence of Second law is *work is a more valuable form of energy transfer than*

heat as heat can never be transformed continuously and completely to work, whereas work can always be transformed continuously and completely to heat.

The following statements summarise the obvious consequences of the Second Law:

- If a system is taken through a cycle and produces work, it must be exchanging heat with at least two reservoir at different temperatures,
- If a system is taken through a cycle while exchanging heat with one reservoir, the work done must be zero or negative,
- Since heat can never be continuously and completely converted into work whereas work can always be continuously and completely converted into heat, work is more valuable form of energy transfer than heat.

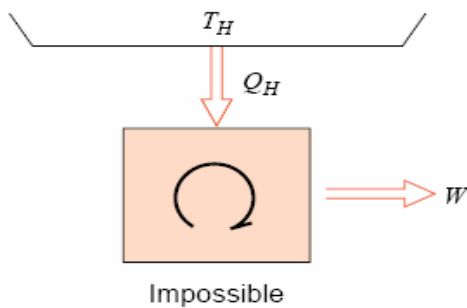

THE KEIVIN-PLANK'S STATEMENT OF THE SECOND LAW

It is impossible to construct a system, which will operate in a cycle, extract heat from a reservoir and do an equivalent amount of work on the surroundings.

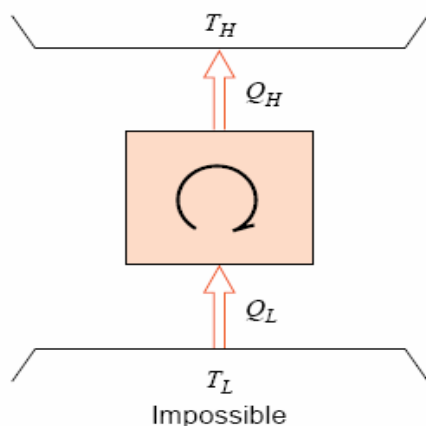

THE CLAUSIUS STATEMENT OF THE SECOND LAW

It is impossible to construct a system, which will operate in a cycle and transfer heat from a cooler to a hotter body without work being done on the system by the surroundings. (Corollary 1)

EQUIVALENCE OF KELVIN PLANK'S AND CLAUSIUS STATEMENTS.

Proof: Suppose the converse of the Clausius' proposition is true. The system can be

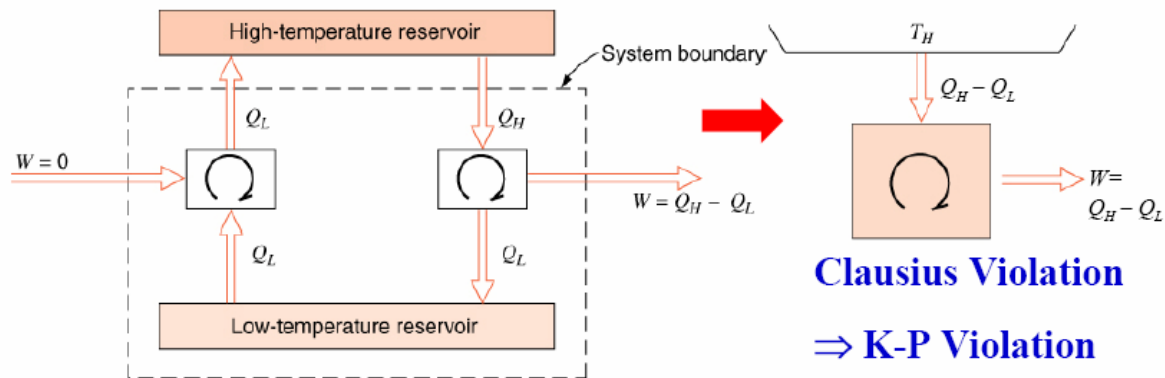

K-P Violation ⇒ Clausius Violation

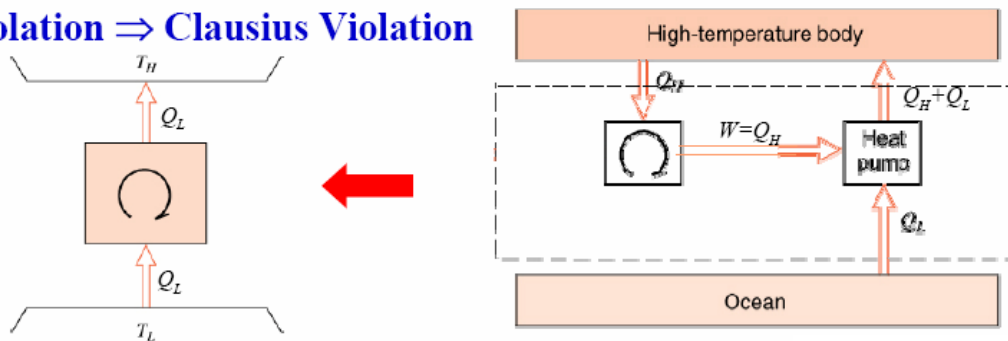

represented by a heat pump for which $W = 0$. If it takes Q units of heat from the cold reservoir, it must deliver Q units to the hot reservoir to satisfy the First Law. A heat engine could also be operated between the two reservoirs; let it be of such a size that it delivers Q units of heat to the cold reservoir while performing W units of work. Then the First Law states that the engine must be supplied with $(W + Q)$ units of heat from the hot reservoir. In the combined plant, the cold reservoir becomes superfluous because the heat engine could reject its heat directly to the heat pump. The combined plant represents a heat engine extracting $(W + Q) - Q = W$ units of heat from a reservoir and delivering an equivalent amount of work. This is impossible according to Kelvin-Planck's statement of Second Law. Hence converse of Clausius' statement is not true and the original proposition must be true.

Reversibility and irreversibility

The Second Law of Thermodynamics enables us to divide all processes into two classes:

- Reversible or ideal process.
- Irreversible or natural process.

A **reversible** process is one, which is performed in such a way that at the end of the process, both the system and the surroundings may be restored to their initial states, without producing any changes in the rest of the universe. Let the state of a system be represented by a , and let the system be taken to state b by following the path $a-b$. In the

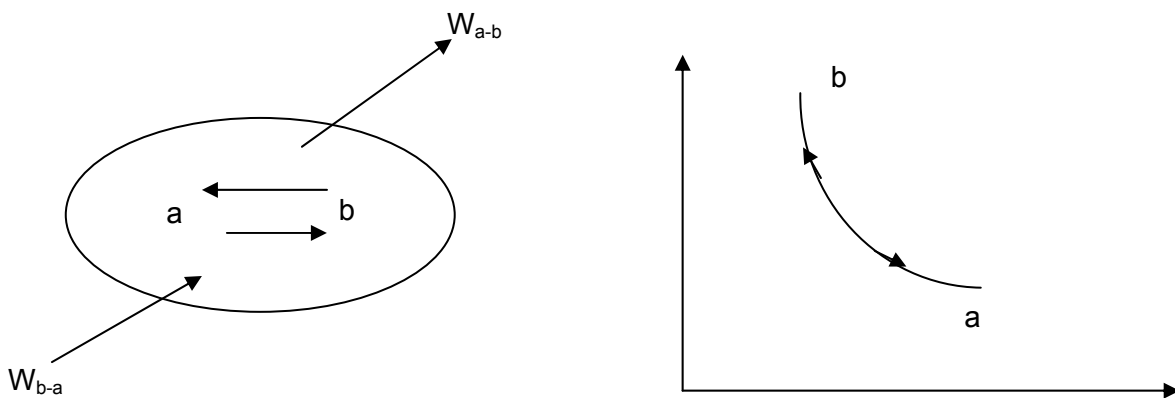

A reversible process

reverse process, the system is taken from state b to a by following the same path $b-a$. If the system and also the surroundings are restored to their initial states (a) and no change in the universe is produced, then the process $a-b$ will be a reversible process.

A reversible process is carried out infinitely slowly with an infinitesimal gradient, so that every state passed through by the system is an equilibrium state.

Any natural process carried out with a finite gradient is an irreversible process. A reversible process, which consists of a succession of equilibrium states, is an idealised hypothetical process, approached only as a limit. All spontaneous processes are irreversible.

Causes of Irreversibility:

- Friction
- Unrestrained expansion
- Heat transfer through a finite temperature difference
- Mixing of two different substances

The lack of equilibrium (mechanical, thermal or chemical) between the system and its surroundings, or between two systems, or two parts of the same system, causes a spontaneous change, which is irreversible. Heat transfer through a finite temperature difference, free expansion are some examples.

The irreversibility of a process may be due to the dissipative effects in which work is done without producing equivalent increase in the kinetic or potential energy of the system. Friction, transfer of electricity through a resistor are some examples.

Question: *If all the heat cannot be converted into work, then what is the maximum possible efficiency?*

Maximum efficiency is achieved by reversible engines, which must

- Always be in equilibrium.
- Avoid friction.
- Avoid heat transfer. If we must have heat transfer it should be through infinitesimal temperature differences 'dT' not finite 'ΔT'.

CARNOT CYCLE

A Carnot cycle consists of

- a) A reversible isothermal process in which heat Q_1 enters the system reversibly from a constant temperature source of T_1

$$Q_1 = U_2 - U_1 + W_{1-2}$$

- b) A reversible adiabatic process (isentropic process) in which work W_T is done by the system adiabatically and reversibly at the expense of its internal energy.

$$0 = U_3 - U_2 + W_{2-3}$$

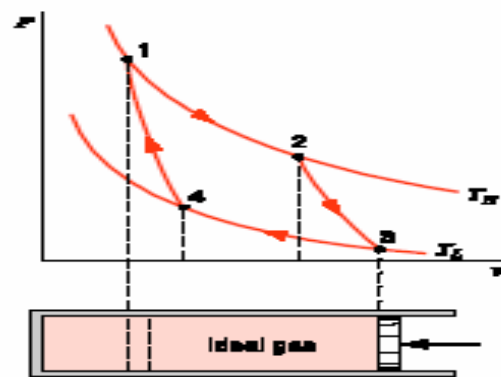
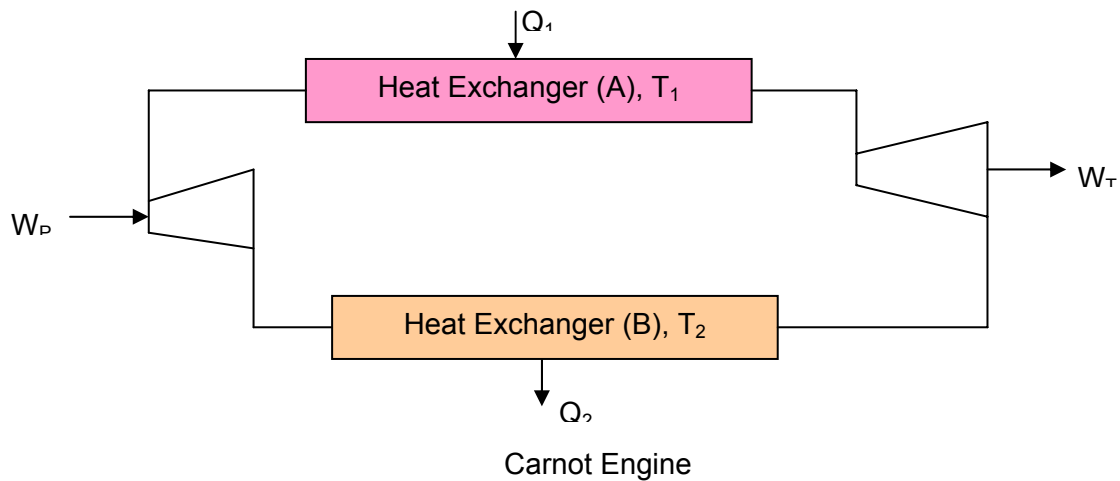

- c) A reversible isothermal process in which heat Q_2 is rejected from the system reversibly from a constant temperature source of T_2

$$-Q_2 = U_4 - U_3 - W_{3-4}$$

- d) A reversible adiabatic process (isentropic process) in which work W_P is done by the system adiabatically and reversibly at the expense of its internal energy.

$$0 = U_1 - U_4 - W_{4-1}$$

$$\text{Net work done} = W_{\text{net}} = W_T - W_P = Q_1 - Q_2$$

REVERSIBLE ENGINES OPERATING BETWEEN ONLY TWO RESERVOIRS

Carnot's Theorem: It is impossible to construct an engine operating between only two heat reservoirs, which will have a higher efficiency than a reversible engine operating between the same two reservoirs. (Corollary 2)

Proof. Assume the converse of this proposition is true. Let X be such an engine having an efficiency η_X . Let it receive heat Q_1 from the source, does work W_X , and reject heat $(Q_1 - W_X)$ to the sink. Then it is assumed that $\eta_X > \eta_R$, where η_R is the efficiency of a reversible engine R operating between the same two reservoirs (a). If the reversible engine also receives heat Q_1 from the source, it will do work W_R such that $W_R < W_X$ and the heat rejected will be $(Q_1 - W_R)$

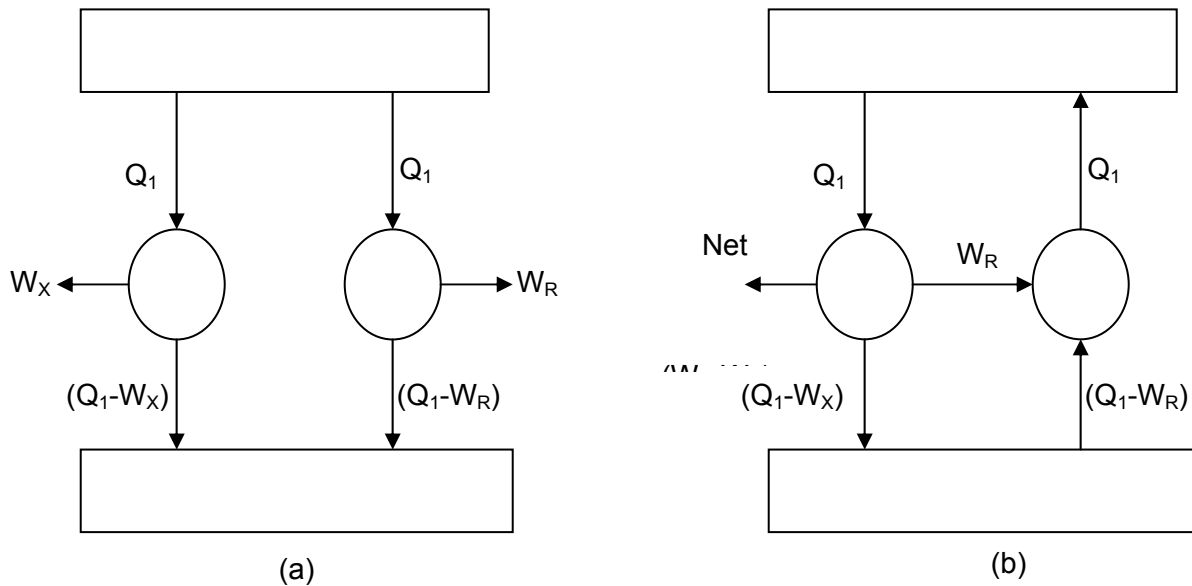

which is greater than $(Q_1 - W_X)$. Let the reversible engine be reversed and act as heat pump (b). It now receives heat $(Q_1 - W_R)$ from the low temperature reservoir, receives work W_R from the surrounding and rejects heat Q_1 to the high temperature reservoir. If the engine X is coupled to the heat pump such that the engine X receives heat Q_1 directly from the heat pump, then the combined plant represents a heat engine receiving heat $(Q_1 - W_R) - (Q_1 - W_X) = (W_X - W_R)$ from the surroundings and delivering an equivalent amount of work. According to Second Law this is impossible and the assumption $\eta_X > \eta_R$ cannot be true. Consequently the original proposition must be true.

Corollary 3: All reversible engines operating between the same two reservoirs have the same efficiency.

Since all reversible engines operating between the same two reservoirs have the same efficiency, this efficiency must depend upon the only feature, which is common to them all viz. the temperature of the reservoirs. It is called **Carnot efficiency**.

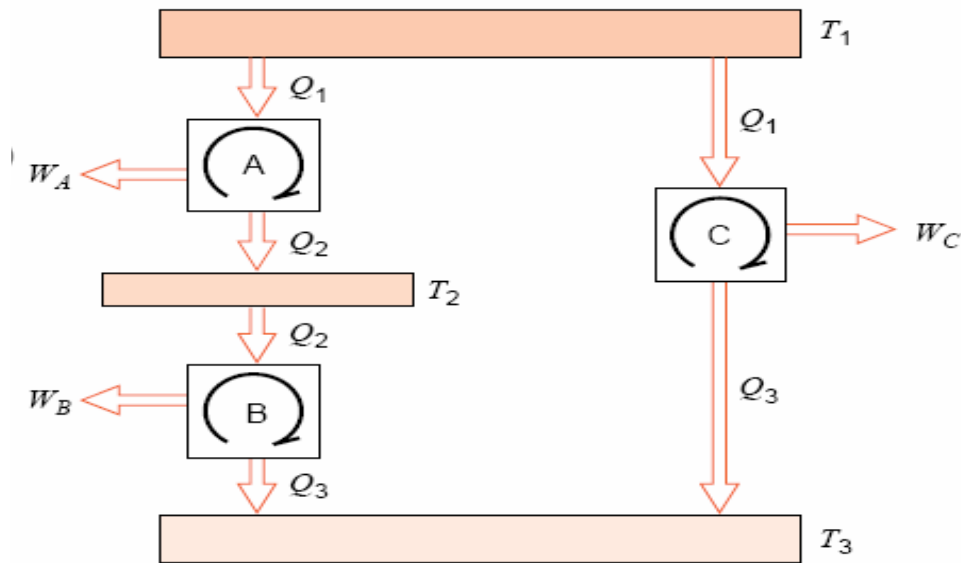

THERMODYNAMIC TEMPERATURE SCALE

Corollary 4. *A scale of temperature can be defined which is independent of any particular thermometric substance, and which provides an absolute zero of temperature.*

Let us consider the reversible engine operating between two reservoirs represented symbolically in Figure. Corollary 3 implies that its efficiency depends only on the temperature of the reservoirs, and therefore that it is independent of the particular properties of the working fluid and of the quantity of heat Q_0 supplied to the engine. But

$$\eta = \frac{Q_0 - Q_1}{Q_0} = 1 - \frac{Q_1}{Q_0}$$

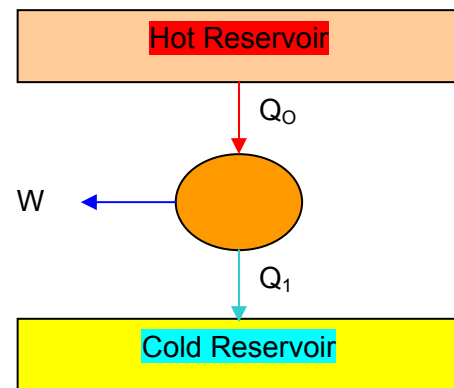

and hence it follows that Q_1/Q_0 is a function only of the temperatures of the reservoirs.

$$\therefore \eta = 1 - \frac{Q_1}{Q_0} = \phi(T_1, T_0)$$

$$\text{Now } \frac{Q_1}{Q_2} = \phi(T_1, T_2)$$

$$\frac{Q_2}{Q_3} = \phi(T_2, T_3)$$

$$\frac{Q_1}{Q_3} = \phi(T_1, T_3)$$

$$\text{Since } \frac{Q_1}{Q_3} = \frac{Q_1 Q_2}{Q_2 Q_3}$$

$$\therefore \phi(T_1, T_3) = \phi(T_1, T_2) \times \phi(T_2, T_3)$$

Since, the left side of the above equation is a function of T_1 and T_3 , the right hand side of the equation will be a function of T_1 and T_3 .

Hence we can conclude that

$$\phi(T_1, T_2) = \frac{f(T_1)}{f(T_2)} \quad \text{and} \quad \phi(T_2, T_3) = \frac{f(T_2)}{f(T_3)}$$

$$\therefore \frac{Q_1}{Q_3} = \phi(T_1, T_3) = \frac{f(T_1)}{f(T_3)}$$

$$\text{In general } \frac{Q_L}{Q_H} = \frac{f(T_L)}{f(T_H)}$$

$$\text{Lord Kelvin proposed that } \frac{Q_L}{Q_H} = \frac{T_L}{T_H}$$

With temperature so defined,

$$\eta = 1 - \frac{Q_L}{Q_H} = 1 - \frac{T_L}{T_H}$$

If Q is measured for several sinks at different temperatures and plotted against the relation between Q and T , we obtain a temperature scale, which is linear in Q . The temperature scale so defined is called the **thermodynamic scale**, because it depends solely on the thermodynamic law and not

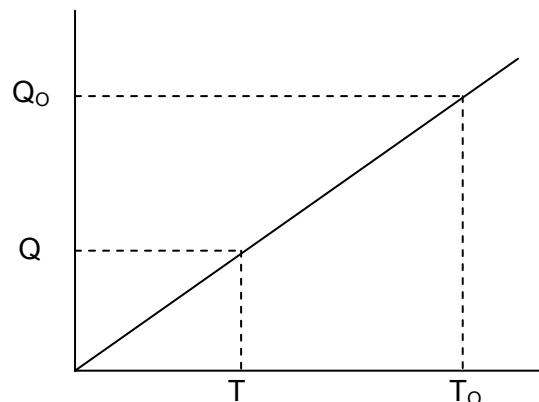

upon the properties of any particular substance.

The thermodynamic scale is an absolute scale because it presents us with the idea of an absolute zero, i.e. $T = 0$ when $Q = 0$. The Second Law states that Q can in fact never be zero, and we may therefore deduce that ***absolute zero is a conceptual limit and not a temperature, which can ever be reached in practice.*** Thus it appears that a definite zero point exists on absolute temperature scale but this point cannot be reached without violation of the Second Law. Hence, the ***Third Law of Thermodynamics can be stated as: It is impossible by any procedure to reduce the temperature of any system to absolute zero in a finite number of operations.***

What we have learned so far:

- The 2nd Law tells us the direction of spontaneous change.
- The 2nd Law gives us the maximum possible efficiency (coefficient of performance) of a heat engine (refrigerator).
- A reversible process is one in which both the system and the surroundings can be returned to their original state.
- To achieve the maximum possible efficiency, we must have a reversible engine (frictionless, adiabatic, isothermal heat transfer, quasi-equilibrium)
- One realisation of such an engine is a Carnot engine.
- All reversible engines have the same efficiency.
- This maximum efficiency depends only on the temperature of the reservoirs – this yielded the thermodynamic temperature scale (K).

Entropy- A Measure of disorder /Irreversibility

The Second Law says that spontaneous change will occur only in a certain direction.

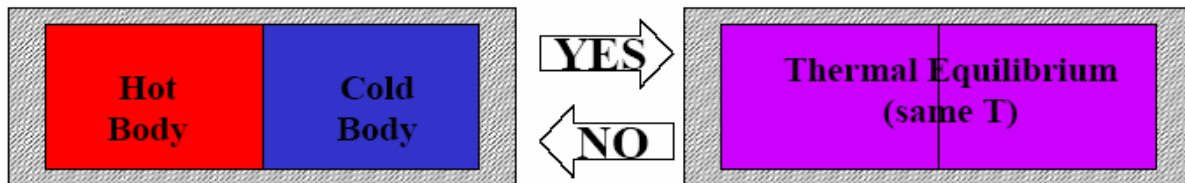

These processes are called irreversible. There are many factors that make the process irreversible, such as

- Friction
- Unrestrained expansion
- Heat transfer through a finite temperature difference
- Mixing of two different substances

Question: *Is there any way to quantify the degree of irreversibility?*

CLAUSIUS INEQUALITY

Whenever a system undergoes a cycle, $\oint \frac{\delta Q}{T}$ is zero if the cycle is reversible and

negative if irreversible, i.e. in general $\oint \frac{\delta Q}{T} \leq 0$.

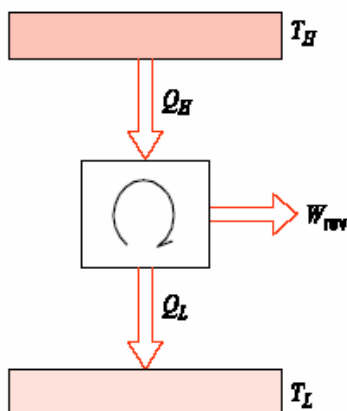

For a Reversible Engine

$$\oint \delta Q = Q_H - Q_L > 0, \text{ since } W = Q_H - Q_L$$

While defining the absolute temperature scale, we showed that

$$\frac{Q_H}{Q_L} = \frac{T_H}{T_L} \text{ or } \frac{Q_H}{T_H} = \frac{Q_L}{T_L}$$

Which gives us
$$\oint \frac{\delta Q}{T} = \frac{Q_H}{T_H} - \frac{Q_L}{T_L} = 0$$

For Irreversible Engine

$$W_{\text{irr}} < W_{\text{rev}} \quad \text{since } W = Q_H - Q_L$$

Hence, $Q_H - Q_{L,\text{irr}} < Q_H - Q_{L,\text{rev}}$

i.e. $Q_{L,\text{irr}} > Q_{L,\text{rev}}$

Therefore,
$$\oint \frac{\delta Q}{T} = \frac{Q_H}{T_H} - \frac{Q_{L,\text{irr}}}{T_L} < 0$$

Hence, for any cycle (reversible or irreversible) we get,

$$\oint \frac{\delta Q}{T} \leq 0.$$

Consequences of the Second Law for non-flow process

ENTROPY – A Property of the System

Corollary: There exists a property of a closed system such that a change in its value is

equal to $\int_1^2 \frac{\delta Q}{T}$ for any reversible process undergone by the system between state 1 and state 2.

Proof.

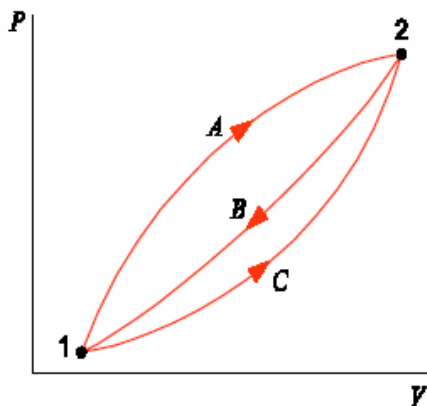

Let us assume that $\int_1^2 \frac{\delta Q}{T}$ depends upon the reversible process as well as upon the states.

Consider two reversible processes A and C by which the system can change from state 1 to state 2. The assumption is that

$$\int_1^2 \left(\frac{\delta Q}{T} \right)_A \neq \int_1^2 \left(\frac{\delta Q}{T} \right)_C$$

In each case, let the system returns to its original state by a third reversible process B. For each of the complete reversible cycles AB and CB we have

$$\oint \left(\frac{\delta Q}{T} \right)_{AB} = \int_1^2 \left(\frac{\delta Q}{T} \right)_A + \int_2^1 \left(\frac{\delta Q}{T} \right)_B$$

and
$$\oint \left(\frac{\delta Q}{T} \right)_{CB} = \int_1^2 \left(\frac{\delta Q}{T} \right)_C + \int_2^1 \left(\frac{\delta Q}{T} \right)_B$$

If the assumption is true then it follows that

$$\oint \left(\frac{\delta Q}{T} \right)_{AB} \neq \oint \left(\frac{\delta Q}{T} \right)_{CB}$$

But this cyclic integral must be equal since they are zero for a reversible cycle (Clausius inequality). Hence, $\int_1^2 \frac{\delta Q}{T}$ is independent of the path of the reversible process

and represents the change in property of the system.

If the property is denoted by S, this corollary can be expressed mathematically as

$$\int_1^2 \left(\frac{\delta Q}{T} \right)_{\text{rev}} = S_2 - S_1$$

or in the differential form as

$$dS = \left(\frac{\delta Q}{T} \right)_{\text{rev}}$$

This property S is called **entropy** of the system.

Entropy change in a process

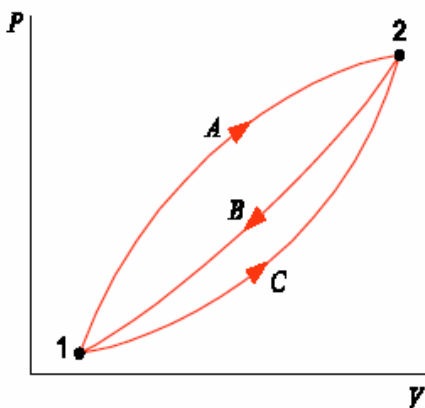

Let us assume A and B are reversible processes and C is an irreversible process. For the reversible cycle consisting of A and B

$$\oint \left(\frac{\delta Q}{T} \right)_{AB} = \int_1^2 \left(\frac{\delta Q}{T} \right)_A + \int_2^1 \left(\frac{\delta Q}{T} \right)_B = 0$$

$$\text{or } \int_1^2 \left(\frac{\delta Q}{T} \right)_A = - \int_2^1 \left(\frac{\delta Q}{T} \right)_B$$

For the irreversible cycle consisting of B and C, by the inequality of Clausius

$$\oint \left(\frac{\delta Q}{T} \right)_{CB} = \int_1^2 \left(\frac{\delta Q}{T} \right)_C + \int_2^1 \left(\frac{\delta Q}{T} \right)_B < 0$$

$$\text{Hence, } -\int_1^2 \left(\frac{\delta Q}{T} \right)_A + \int_1^2 \left(\frac{\delta Q}{T} \right)_C < 0$$

$$\text{i.e. } \int_1^2 \left(\frac{\delta Q}{T} \right)_A > \int_1^2 \left(\frac{\delta Q}{T} \right)_C$$

Since the process A is reversible

$$\int_1^2 \left(\frac{\delta Q}{T} \right)_A = \int_1^2 (dS)_A$$

Since entropy is a property, changes for the path A and C would be the same.

Therefore,

$$\int_1^2 (dS)_A = \int_1^2 (dS)_C$$

$$\text{Hence, } \int_1^2 (dS)_C > \int_1^2 \left(\frac{\delta Q}{T} \right)_C$$

Thus for an irreversible process,

$$dS > \frac{\delta Q}{T}$$

whereas for a reversible process

$$dS = \left(\frac{\delta Q}{T} \right)_{\text{rev}}$$

Therefore in general

$$dS \geq \frac{\delta Q}{T}$$

$$\text{or } S_2 - S_1 \geq \int_1^2 \frac{\delta Q}{T}$$

For an isolated system which does not undergo any energy interchange with the surroundings, $\delta Q = 0$.

Therefore for an isolated system $dS \geq 0$.

For a reversible system, $dS = 0$ or $S = \text{constant}$.

Thus the *entropy for an isolated system can never decrease*. It always increases and remains constant only when the process is reversible. This is known as **entropy principle**.

Change of Entropy for special Reversible processes:

$$dS = \left(\frac{\delta Q}{T} \right)_{\text{rev}} \quad \text{or} \quad s_2 - s_1 = \left(\frac{\delta Q}{T} \right)_{\text{rev}}$$

1) Adiabatic

$$\delta Q = 0 \quad \text{or} \quad dS = \left(\frac{\delta Q}{T} \right)_{\text{rev}} = 0$$

Reversible adiabatic is known as isentropic process.

2) Isothermal

$$s_2 - s_1 = \frac{1}{T_H} \int_1^2 (\delta Q)_{\text{rev}} = \frac{(Q_{1-2})_{\text{rev}}}{T_H}$$

or $(Q_{1-2})_{\text{rev}} = T (s_2 - s_1)$

Summary

- Since entropy is a property, it does not matter how we get from state 1 to state 2. Thus, we can choose the most convenient reversible path to compute the integral.
- $S_2 - S_1$ is independent of the process – once evaluated, it is the same for all processes.
- Entropy of all pure substances is taken to be zero at $T = 0$ K.
- In the absence of chemical reactions, an arbitrary reference may be selected as in the case of internal energy and enthalpy. (e.g. $s_f = 0$ at triple point for water).

ENTROPY OF PURE SUBSTANCE

In the saturated region:

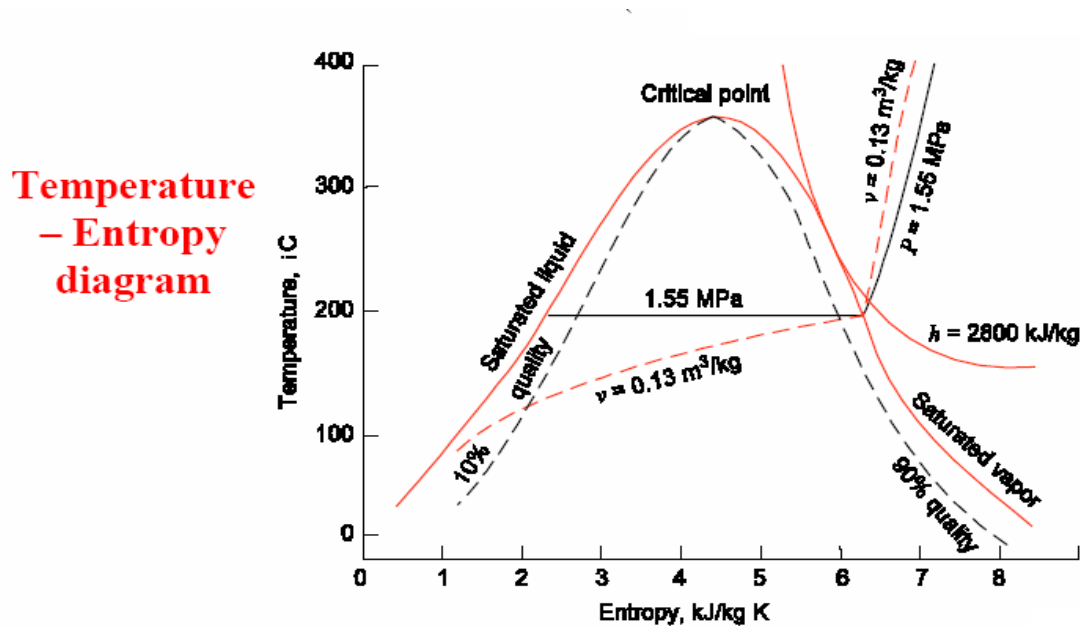

$$s = (1-x) s_f + x s_g \quad \text{or} \quad s = s_f + x s_{fg}$$

where, s is specific entropy in kJ/kg K = S / m .

ENTROPY CHANGE OF AN IDEAL GAS

From First Law: $\delta Q = du + \delta W = du + pdv$

For a reversible process:

$$\left(\frac{\delta Q}{T} \right)_{\text{rev}} = ds \quad \text{or} \quad \delta Q = T ds \quad (\text{from Second Law})$$

Hence,

$$T ds = du + pdv$$

Again

$$dh = du + d(pv) = du + pdv + vdp$$

So

$$T ds = dh - vdp$$

Hence, the general property relations are

$$T ds = du + pdv$$

$$Tds = dh - vdp$$

For ideal gas,

$$du = C_v dT ; dh = C_p dT \text{ and } pv = RT$$

The entropy change between two states 1 and 2 can be computed as

$$\begin{aligned} ds &= \frac{du}{T} + \frac{p}{T} dv \\ &= C_v dT + R \frac{dv}{v} \end{aligned}$$

Hence,

$$\underline{s_2 - s_1 = C_v \ln \frac{T_2}{T_1} + R \ln \frac{v_2}{v_1}}$$

Again

$$\frac{p_1 v_1}{T_1} = \frac{p_2 v_2}{T_2} \quad \text{or} \quad \frac{v_2}{v_1} = \left(\frac{p_1 T_2}{p_2 T_1} \right)$$

$$\therefore s_2 - s_1 = C_v \ln \frac{T_2}{T_1} + R \ln \left(\frac{p_1 T_2}{p_2 T_1} \right)$$

$$\text{or } s_2 - s_1 = (C_v + R) \ln \frac{T_2}{T_1} - R \ln \left(\frac{p_1}{p_2} \right)$$

$$\text{i.e. } \underline{s_2 - s_1 = C_p \ln \frac{T_2}{T_1} - R \ln \left(\frac{p_1}{p_2} \right)}$$

Similarly, substituting for $\frac{T_2}{T_1}$ we get

$$\underline{s_2 - s_1 = C_v \ln \frac{p_2}{p_1} + C_p \ln \frac{v_2}{v_1}}$$

For Constant Volume Process

$$\frac{p_1}{T_1} = \frac{p_2}{T_2} \quad ; \text{ Hence } s_2 - s_1 = C_v \ln \frac{T_2}{T_1}$$

For Constant Pressure Process

$$\frac{v_1}{T_1} = \frac{v_2}{T_2} \quad ; \text{ Hence } s_2 - s_1 = C_p \ln \frac{T_2}{T_1}$$

For Adiabatic Process

$$s_2 = s_1$$

For Isothermal Process

$$P_1 v_1 = p_2 v_2 ; \text{ hence } s_2 - s_1 = R \ln \frac{v_2}{v_1} = -R \ln \frac{p_2}{p_1}$$

CHAPTER 3 Properties of a Pure Substance and steam power cycle

A pure substance is one that has homogeneous and invariable chemical composition. It may exist in more than one phase, but chemical composition is same for all the phases. Thus, water, mixture of water and ice and water and steam are all examples of pure substance. Sometimes a mixture of gases e.g. air is considered as pure substance.

We have seen that two independent properties are sufficient to determine thermodynamic state of a fluid when it is in equilibrium. Any other thermodynamic property is a function of the chosen pair of independent properties. We shall first consider the relation between the primary properties p , v and T , the equation expressing this relation for any particular fluid being called the equation of state or characteristic equation of the fluid.

p-v-T DATA OF WATER

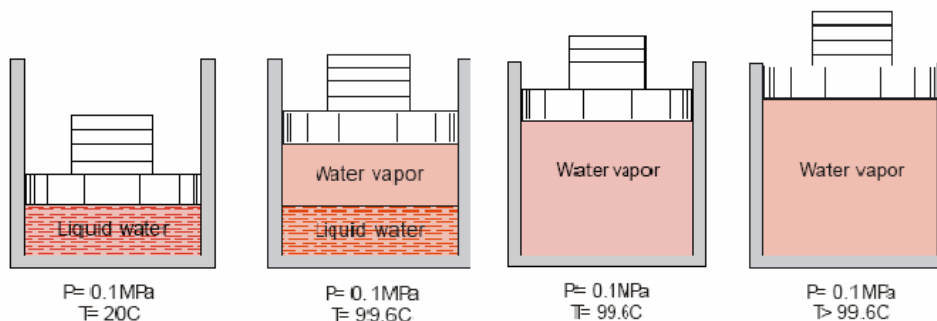

1. **Compressed or subcooled liquid** – *not ready to vaporize (AB)*
2. **Saturated liquid** – *just ready to vaporize (B)*
3. **Saturated liquid/vapor mixture** – *liquid vaporizing, vapor condensing (equil)*
4. **Saturated vapor** – *just ready to condense (C)*
5. **Superheated vapor** – *not ready to condense (CD)*

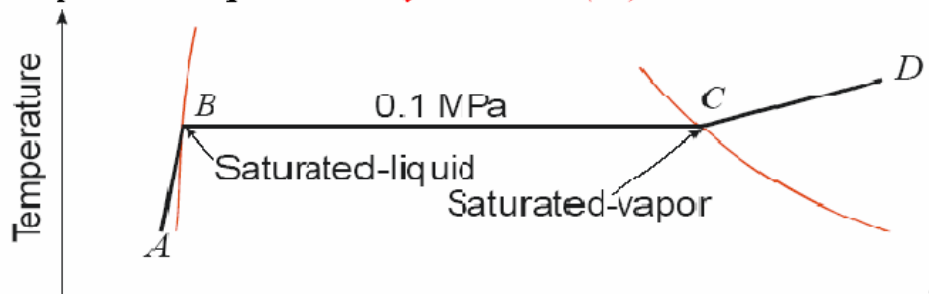

Since we have three variables to consider, the obvious procedure is to measure the variation of one with another while the third is kept constant and repeat this for a range of values of the third variable.

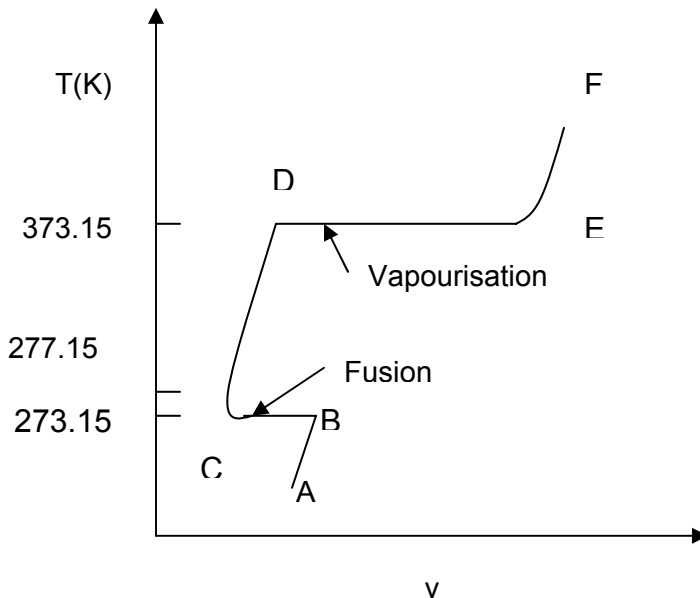

Imagine unit mass of ice below the freezing point, enclosed in a cylinder by a piston under a constant load of 1 atmosphere (1 atm. = 1.01325 bar = 101.325 kPa). If heat is added to the cylinder while keeping the pressure constant, the temperature rises and ice expands until a temperature of 273.15 K (0°C) is reached (AB) as shown in Fig. Further heating does not raise the

temperature of ice but causes a change to the liquid phase (BC). The change of phase occurs at a constant temperature and by reduction of specific volume. The heat required for this process is known as **latent heat of fusion**. Further heating results in a rise of temperature of liquid and a further contraction in volume until the temperature is about 4°C and subsequent expansion until a temperature of 373.15 K (100°C) is reached (point D). At this point a second phase change occurs at constant temperature with a large increase in volume until the liquid has been vaporised (point E). The heat required in this case is called the **latent heat of vaporisation**. When vaporisation is complete, the temperature rises again on heating (line EF). The heat transferred to a substance while the temperature changes is sometimes referred to as **sensible heat**. This constant pressure lines are called **isobars**.

If the pressure is reduced, there is a slight rise in the melting point and also there is a marked drop in the boiling point of water and a marked increase in the change in volume, which accompanies evaporation. When the pressure is reduced to 0.006113

bar (0.6113 kPa), the melting point and boiling point temperatures become equal and change of phase, ice-water-steam, are represented by a single line. The temperature at which this occurs has been accepted internationally as a fixed point for the absolute temperature scale and is by definition 273.16 K. Only at this temperature and pressure of 0.6112 kPa, can ice, water and steam coexists in thermodynamic equilibrium in a closed vessel and is known as **triple point**. If the pressure is reduced further, the ice, instead of melting, sublimates directly into steam.

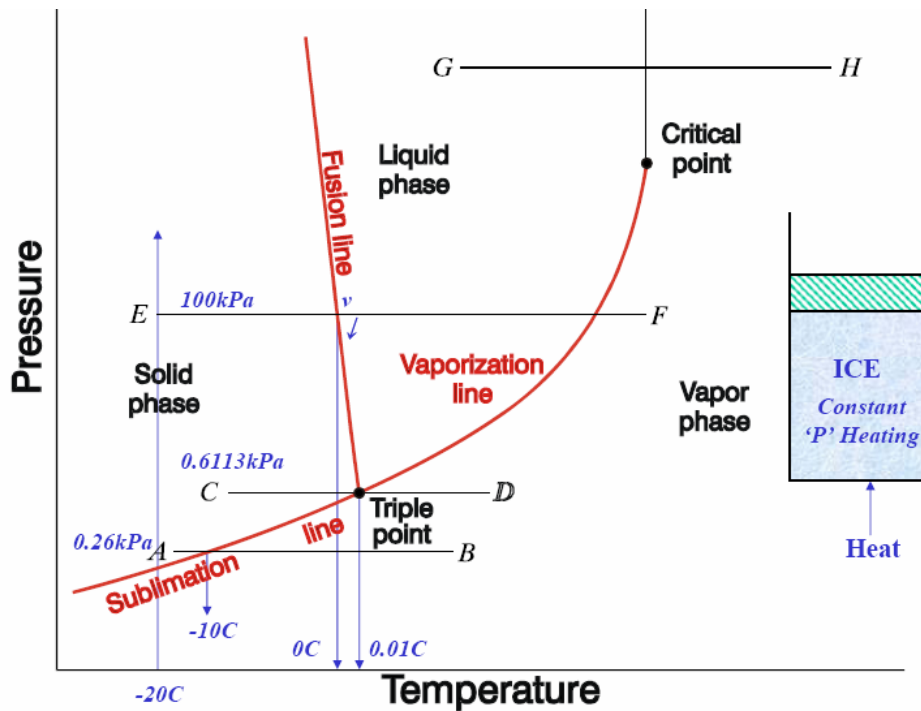

Consider now the behaviour at pressure above atmospheric. The shape of the curve is similar to that of the atmospheric isobar, but there is a marked reduction in the change in volume accompanying evaporation. At a sufficiently high pressure, this change in volume falls to zero and the horizontal portion of the curve reduces to a point of inflexion. This is referred to as critical point. The values of pressure and temperature at which the critical point is reached are

$$p_c = 221.2 \text{ bar} = 22.12 \text{ MPa}; \quad T_c = 647.3 \text{ K}; \quad v_c = 0.00317 \text{ m}^3/\text{kg}.$$

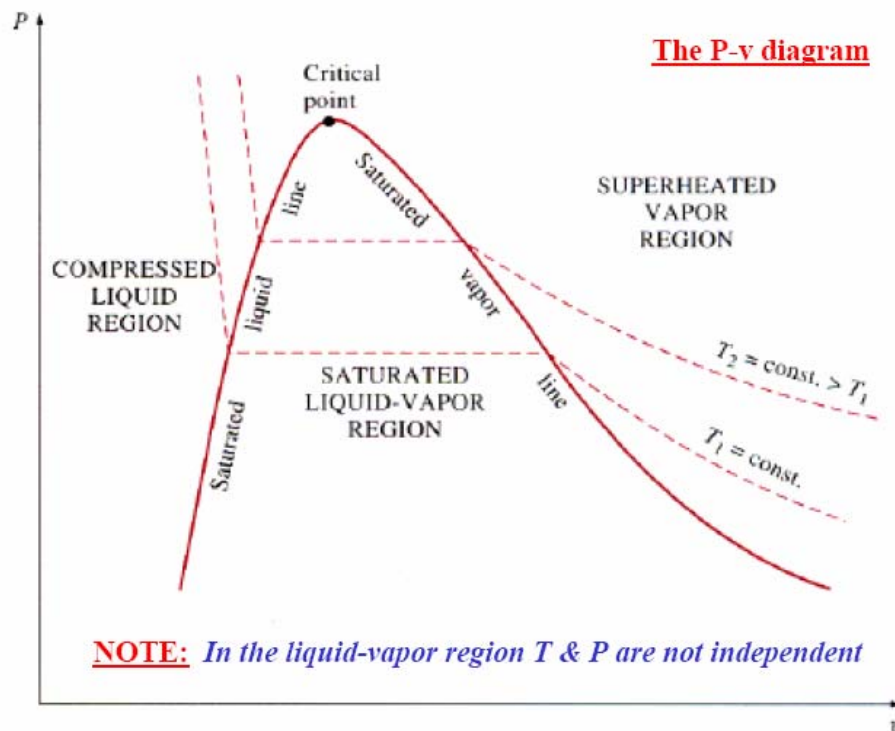
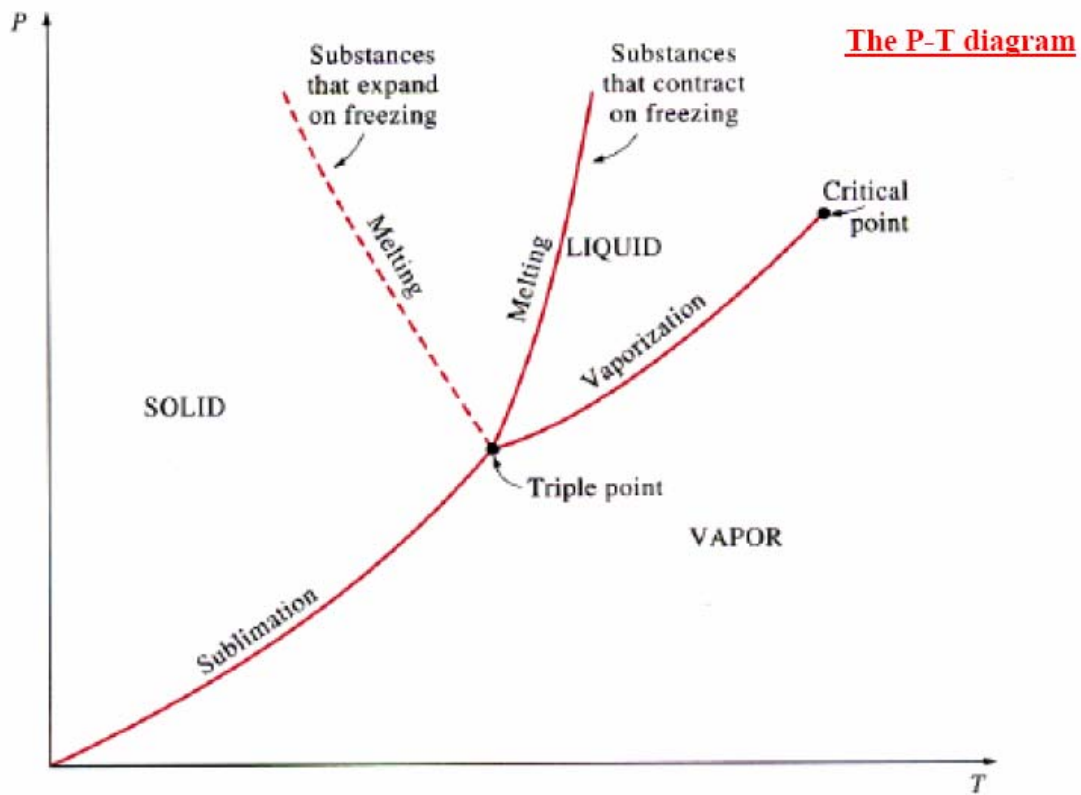

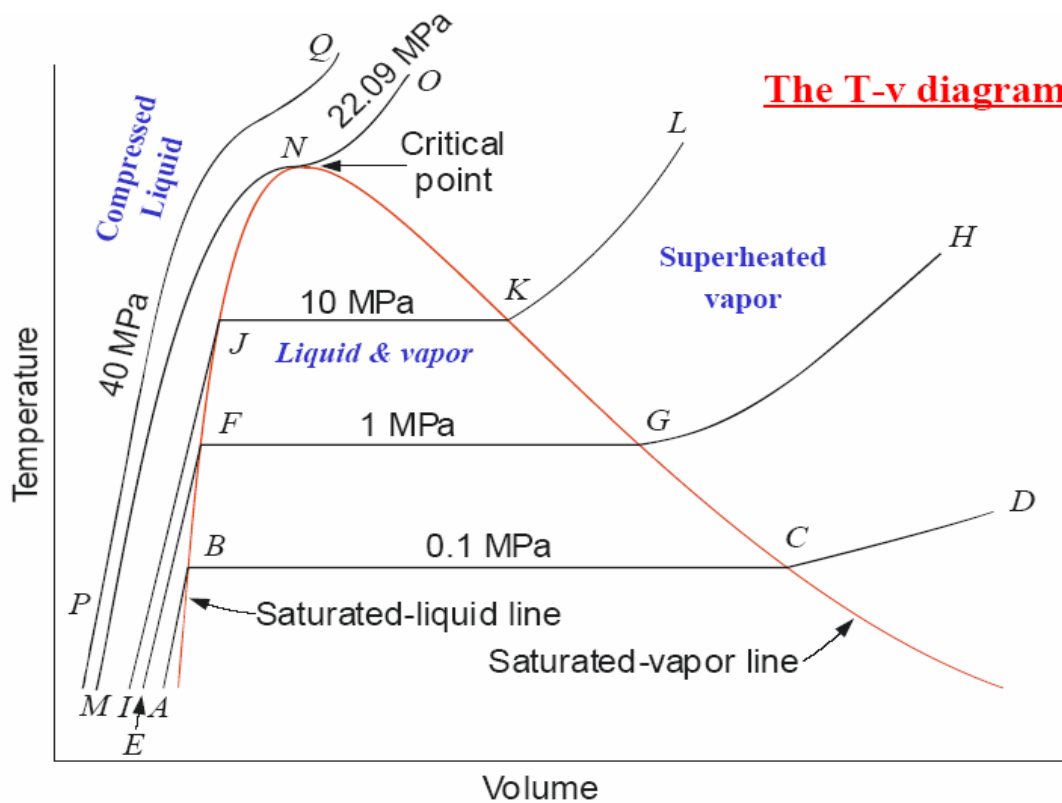

The pressure at which liquid vaporises or condenses is called **saturation pressure** corresponding to a given temperature. Alternately, the temperature at which this phenomena occur is called **saturation temperature** corresponding to the given pressure.

A vapour in a state lying along the saturated vapour line is also called **dry saturated vapour** and the vapour lying right of this line is called **superheated vapour**.

IMPORTANT POINTS TO BE REMEMBERED

- **Saturation temperature:** Temperature at which a pure substance changes phase at a given pressure.
- **Saturation pressure:** Pressure at which a pure substance changes phase at a given temperature.
- **Latent heat:** The amount of energy absorbed or released during a phase-change.

- **Melting/freezing:** *Latent heat of fusion.*
- **Evaporation/condensation:** *Latent heat of vaporization.*
- **Temperature at which water starts boiling depends on the pressure => if the pressure is fixed, so is the boiling temperature.**

TABLE OF PROPERTIES OF WATER

(i) Saturated Table

P	t_s	v_f	v_g	u_f	u_g	h_f	h_g	s_f	s_g

Now how many properties do we need to know to determine the thermodynamic state?

For a single phase we need to know only two independent properties like (P, T), (T, v), etc.

For a two-phase mixture, p and T are not independent. Hence, we require defining “quality”.

Quality or Dryness fraction: $x = \frac{m_v}{m_v + m_l}$

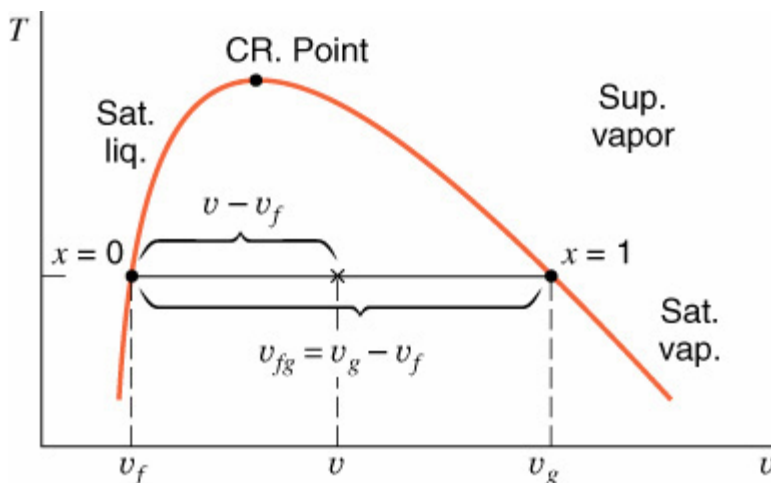

Value of x varies from 0 to 1. For saturated water, when water just starts boiling, $x = 0$ and for saturated vapour, when vaporisation is complete, $x = 1$ and the vapour is called dry saturated.

Let V be the total volume of a liquid vapour mixture of quality x.

V_f the volume of saturated liquid

and V_g the volume of saturated vapour, the corresponding masses are m , m_f , and m_g respectively.

Now $m = m_f + m_g$

and $V = V_f + V_g$

or $m v = m_f v_f + m_g v_g = (m - m_g) v_f + m_g v_g$

or $v = \frac{(m - m_g)}{m} v_f + \frac{m_g}{m} v_g$

or $v = (1 - x) v_f + x v_g$

Again, enthalpy $H = H_f + H_g$

or $m h = m_f h_f + m_g h_g = (m - m_g) h_f + m_g h_g$

or $h = \frac{(m - m_g)}{m} h_f + \frac{m_g}{m} h_g$

or $h = (1 - x) h_f + x h_g$

Similarly,

$$s = (1 - x) s_f + x s_g$$

where, h is the specific enthalpy and s the specific entropy. We shall discuss about these properties in the later chapters.

Now

$$v = (1 - x) v_f + x v_g = v_f + x (v_g - v_f) = v_f + x v_{fg}$$

Similarly,

$$u = u_f + x u_{fg}$$

$$h = h_f + x h_{fg}$$

$$s = s_f + x s_{fg}$$

where, $v_{fg} = v_g - v_f$; $u_{fg} = u_g - u_f$; $h_{fg} = h_g - h_f$ etc.

ii) Superheated steam Table

p (t _s)		t	200	300	400
15 (198.3)	v u h s					
20 ()	v u h s					

IDEAL GAS (PERFECT GAS)

From experimental observations it has been established that the following relation can express the $p - v - T$ behaviour of gases at the low pressure

$$p \bar{v} = \bar{R} T$$

where, \bar{R} is the universal gas constant, 8.3143 J/mol K and \bar{v} is the molar specific volume, m³/gmol. Dividing the equation (5.14) by the molecular weight M , we get

$$p v = R T$$

where v is the specific volume, m³/kg, and R is the characteristic gas constant. It follows from the above equations that this equation of state can be written in terms of total volume, V , of the gas as

$$p V = n \bar{R} T$$

$$p V = m R T$$

where, n is the number of moles and m is the mass of the gas. The above equation can be written for the two states of the gas as

$$\frac{p_1 V_1}{T_1} = \frac{p_2 V_2}{T_2}$$

The above equations are called the ideal gas equation of state. At very low pressure or density, all gases and vapour approach ideal gas behaviour.

Summary

Ideal Gas: When is it a good approximation?

- Low density \Rightarrow low pressure, high temperature

Vapour Power Cycles and Processes.

About 80% of the electrical power is generated by steam power plants in which working fluid (normally water) undergoes a cyclic change in phase from liquid state to vapour state and back to the original liquid state. This change in phase is brought about by transfer of heat to and from the working fluid. The analysis of such plants is based on idealized cycle that may be closely approximated to the working of the actual plant.

THERMAL EFFICIENCY

The thermal efficiency of a cycle is defined as the ratio of the energy output to the energy input according to the relation

$$\eta_{th} = \frac{W_n}{Q_H}$$

where W_n is the net work output of the cycle and Q_H is the heat supplied to the working fluid from the high temperature source.

In many situations, however, we like to evaluate the thermal efficiency of a certain process, e.g. the efficiency of compression process in a compressor or the efficiency of an expansion process in a turbine.

The compressor efficiency applied to a pump or compressor is defined as the ratio of theoretical isothermal work W_T (in case of reciprocating compressor) or isentropic work W_s (in case of rotary compressor or pump) to the actual work, W_{ac}

$$\eta_c = \frac{W_T}{W_{ac}} \quad (\text{for reciprocating compressor})$$

or
$$\eta_c = \frac{W_s}{W_{ac}} \quad (\text{for rotary compressor or pump}).$$

The expansion efficiency applied to a turbine is defined as the ratio of the actual work W_{ac} to the isentropic work W_s

$$\eta_T = \frac{W_{ac}}{W_s}$$

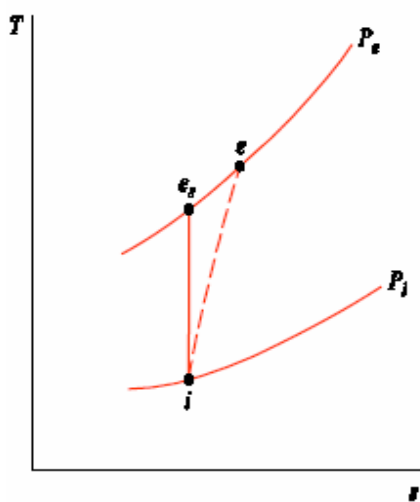

Compressor or Pump

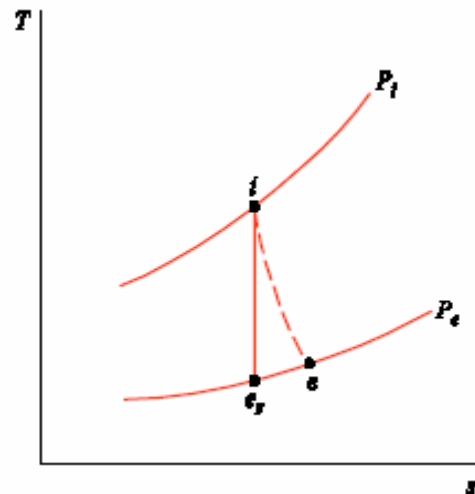

Turbine

IDEALISED STEAM POWER CYCLE (CARNOT VAPOUR CYCLE)

The efficiency of the Carnot Cycle is maximum and it does not depend on the working fluid. It is, therefore, natural to examine if a steam power plant can be operated on Carnot cycle.

1-2 → Isentropic compression in pump.

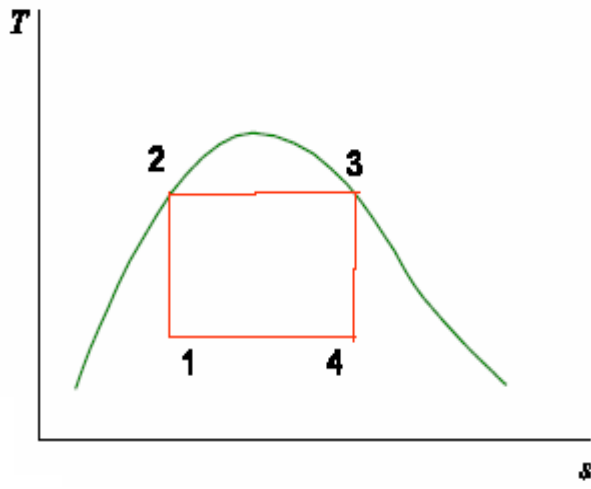

2-3 → Constant Pressure heat addition in boiler.

3-4 → Isentropic expansion in turbine.

4-1 → Constant pressure heat removal in condenser.

The efficiency is given by

$$\eta_{\text{cycle}} = \frac{W_{\text{net}}}{Q_H} = \frac{Q_H - Q_L}{Q_H} = 1 - \frac{Q_L}{Q_H} = 1 - \frac{T_L}{T_H}$$

where Q_H = heat transferred to working fluid

Q_L = heat transferred from working fluid

Practical Problems

The constant pressure heat addition process 2-3 can be achieved in boiler. However, for process

- I. 3-4 Turbine has to handle high moisture content. Liquid droplets can damage or erode turbine blades.
- II. 4-1 condensing process in condenser must be terminated at state 1, where the working fluid is a mixture of liquid water and vapour. It is impossible to attain such condensation.
- III. 1-2 Pump that handles two-phase fluid is not practical.

Due to these inherent practical difficulties, Carnot Cycle remains an ideal one.

RANKINE CYCLE

The simplest way of overcoming the inherent practical difficulties of Carnot Cycle without deviating too far from it is to keep processes 2-3 and 3-4 of Carnot Cycle unchanged and to continue the process 4-1 in the condenser until all vapour is converted to liquid water. Water is then pumped into Boiler till its pressure is raised to

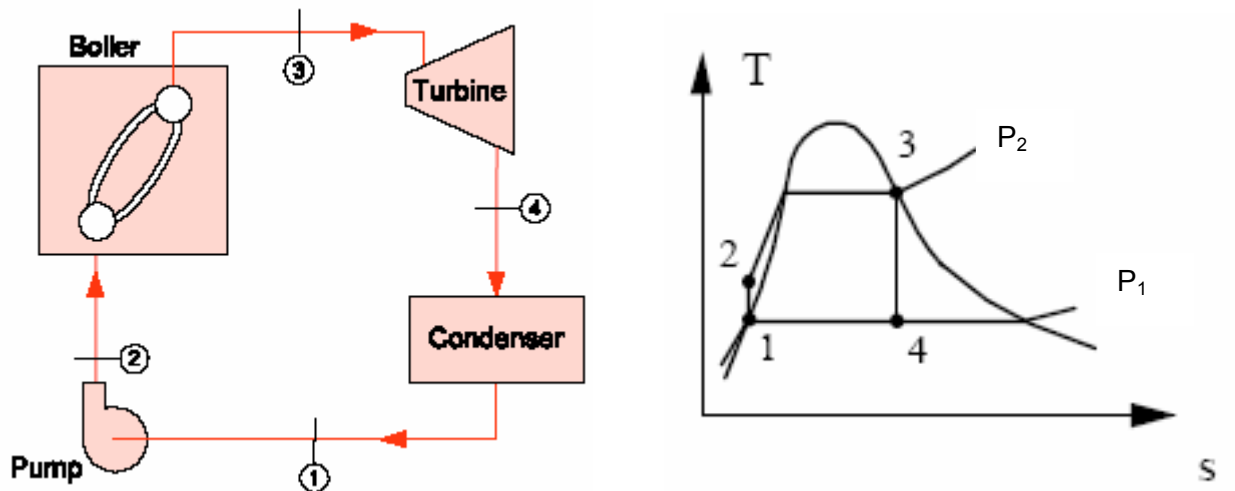

the pressure corresponding to state 2 and the cycle is completed. Such a cycle is known as Rankine Cycle.

Processes:

- 1-2 → Isentropic (reversible adiabatic) compression in pump.
- 2-3 → Constant Pressure heat addition in boiler.
- 3-4 → Isentropic expansion in turbine.
- 4-1 → Constant pressure heat removal in condenser.

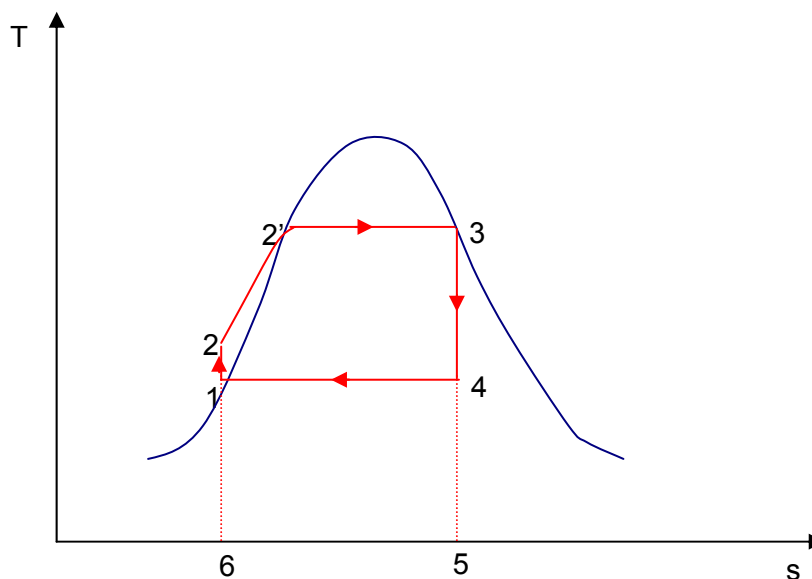

If changes in kinetic and potential energies are neglected, the area under the curve 2-3 i.e. area 2-2'-3-5-6-2 represents the heat transfer to the working fluid in Boiler, which is equal to $(h_3 - h_2)$ and area under the curve 1-2 i.e. area 1-4-5-6-1 represents the heat transferred from the working fluid in condenser, which is equal to $(h_4 - h_1)$. The difference between the two areas, namely area 1-2-2'-3-4-1, represents the work obtained from the cycle. The thermal efficiency of the cycle is given by

$$\begin{aligned}\eta_{\text{th}} &= \frac{W_{\text{net}}}{Q_{\text{H}}} = \frac{\text{area } 1-2-2'-3-4-1}{\text{area } 2-2'-3-5-6-2} \\ &= \frac{(h_3 - h_2) - (h_4 - h_1)}{(h_3 - h_2)} \\ &= \frac{(h_3 - h_4) - (h_2 - h_1)}{(h_3 - h_2)} = \frac{W_{\text{T}} - W_{\text{P}}}{Q_{\text{H}}}\end{aligned}$$

where W_{T} and W_{P} are the turbine work and pump work respectively per kg of steam flow through the cycle and h_1, h_2, h_3, h_4 are the specific enthalpies of the working fluid.

We know that the efficiency of the Carnot cycle depends only on the temperature levels of high and low temperature reservoirs. Efficiency of the Rankine cycle similarly depends on the average temperature at which the heat is transferred to and from the working fluid. Any change that increases the average temperature at which heat is transferred to the working fluid will increase the efficiency of the Rankine cycle. Similarly, any change that decreases the average temperature at which heat is transferred from the working fluid will increase the efficiency of the Rankine cycle.

An advantage of the Rankine cycle over all other power cycles is its low back work ratio, which is expressed as the ratio of the pump work to the turbine work, i.e.

$$\text{Back work ratio} = \frac{W_{\text{P}}}{W_{\text{T}}}$$

METHODS OF IMPROVING THE EFFICIENCY OF RANKINE CYCLE

The Rankine cycle efficiency is given by

$$\eta_{\text{th}} = \frac{(h_3 - h_4) - (h_2 - h_1)}{(h_3 - h_2)} = \frac{W_{\text{T}} - W_{\text{P}}}{Q_{\text{H}}}$$

Since the pumping work is very small compared to the turbine work, it may be neglected. Hence, the efficiency of the Rankine cycle can be approximated as

$$\eta_{\text{th}} = \frac{(h_3 - h_4)}{(h_3 - h_2)} = \frac{(\Delta h)_s}{(h_3 - h_2)}$$

It can be seen that the Rankine efficiency depends on three values, h_2 , h_3 and turbine expansion work $(\Delta h)_s$. The enthalpy of the steam entering the turbine h_3 is determined by the pressure and temperature of the steam entering the turbine. The enthalpy of feed water h_2 is determined by the condenser pressure (as in this case $h_2 = h_1$ since the pump work is negligible). The isentropic heat drop $(\Delta h)_s$ in the turbine is determined by the pressure and temperature at the entrance of steam turbine and the pressure at the end of expansion in the turbine. That means the Rankine efficiency depends on pressures P_1 (i.e. P_4), P_2 (i.e. P_3) and temperature T_3 .

a) Effect of Lowering Condenser pressure

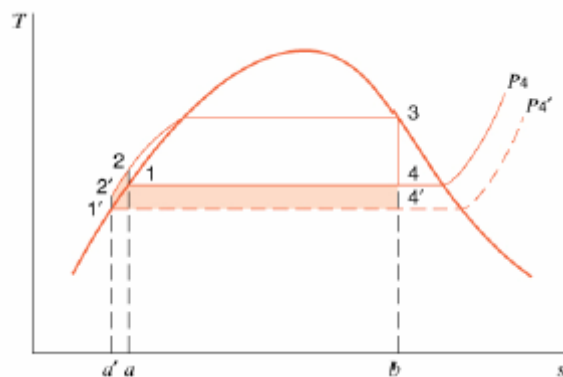

temperature.

By lowering the condenser pressure we can achieve higher efficiency as the enthalpy of the steam leaving the turbine decreases thereby increasing heat drop $(\Delta h)_s$ in the turbine. However, there is a limit to which the condenser pressure can be lowered and this limit is the saturated pressure P_{sat} corresponding to the condenser temperature.

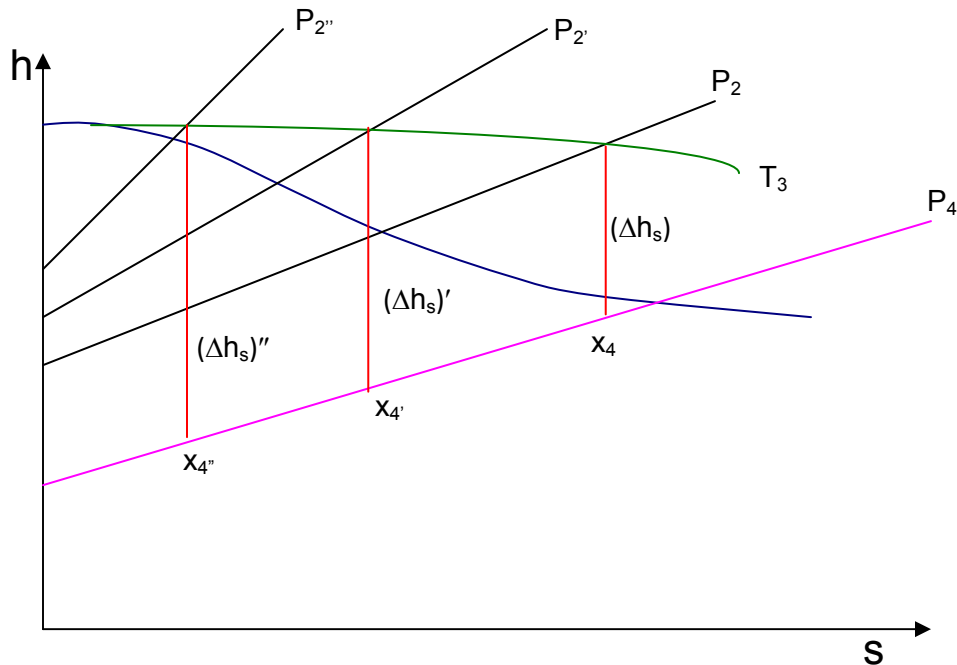
b) Effect of Increasing Steam pressure in the Boiler

In this analysis the maximum temperature of the steam T_3 as well as the exhaust pressure P_4 are held constant.

P_2, P_2', P_2'' are the pressures of steam at the entrance of the turbine at temperature T_3 such that $P_2'' > P_2' > P_2$. x_4, x_4', x_4'' are the qualities of steam at the exhaust pressure P_4 of the turbine, where $x_4 > x_4' > x_4''$. It is evident that as pressure in the Boiler increases, the isentropic heat drop $(\Delta h)_s$ increases with the result that the Rankine cycle efficiency increases.

An adverse effect resulting from increasing the steam pressure in the Boiler is the greater amount of moisture in the steam at the end of expansion in the turbine. If the moisture content in the turbine exceeds $\sim 10\%$, the turbine blades also get eroded which leads to serious wear of the turbine blades.

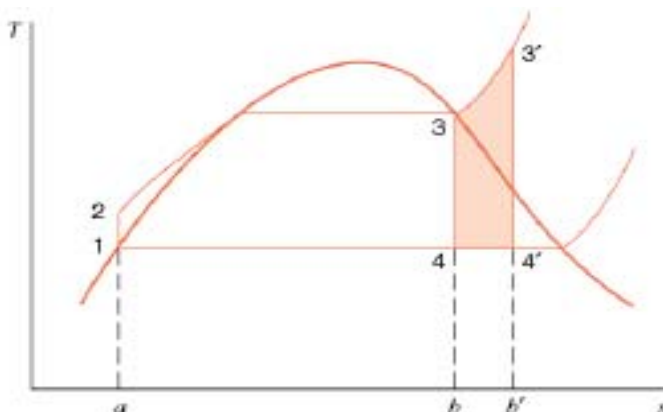
c) Effect of Superheating of Steam in the Boiler

The moisture in the steam at the end of the expansion can be reduced by superheating and

turbine to the exhaust pressure. Reheating has a two-fold advantage. Firstly, it reduces excessive moisture in the low pressure stages of turbine, and secondly, a large amount of work may be obtained at the cost of additional consumption of heat required for reheating the steam. The net effect is an improvement in the thermal efficiency of the cycle. Thus with reheat cycle, the efficiency of the cycle is increased without increase in the maximum pressure or maximum temperature of the cycle.

The efficiency of the reheat cycle is given by

$$\eta_{th} = \frac{W_T - W_P}{Q_H} = \frac{(h_3 - h_4) + (h_5 - h_6) - (h_2 - h_1)}{(h_3 - h_2) + (h_5 - h_4)}$$

REAL RANKINE CYCLE: DEVIATION FROM IDEAL CYCLES

a) Turbine and pump losses

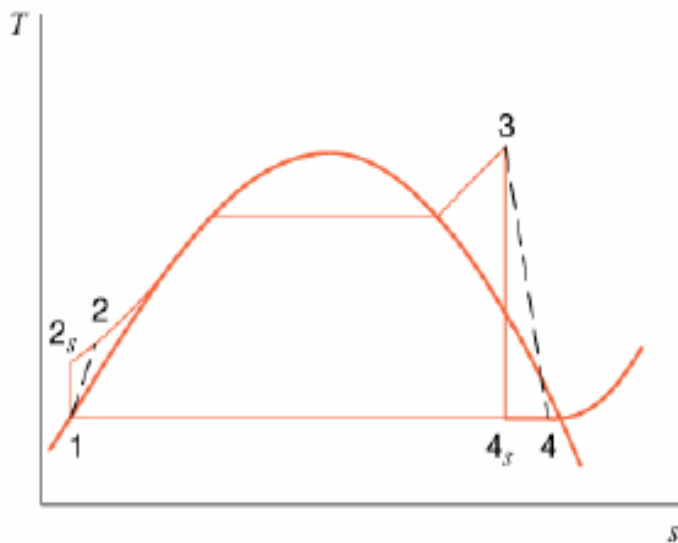

1-2s & 3-4s → Isentropic drop.

1-2 & 3-4 → irreversible drop.

a-b: friction loss → entropy increases

b-c: heat loss → entropy decreases.

b) Pump losses

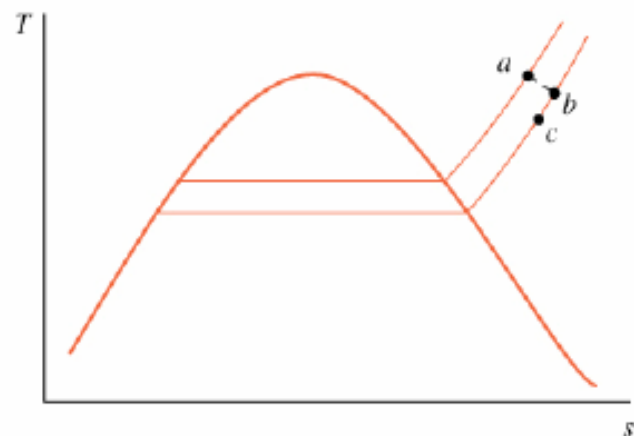

Example

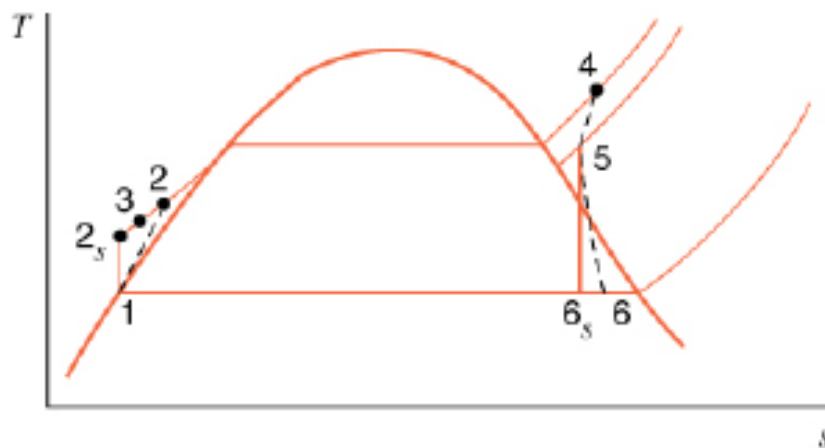
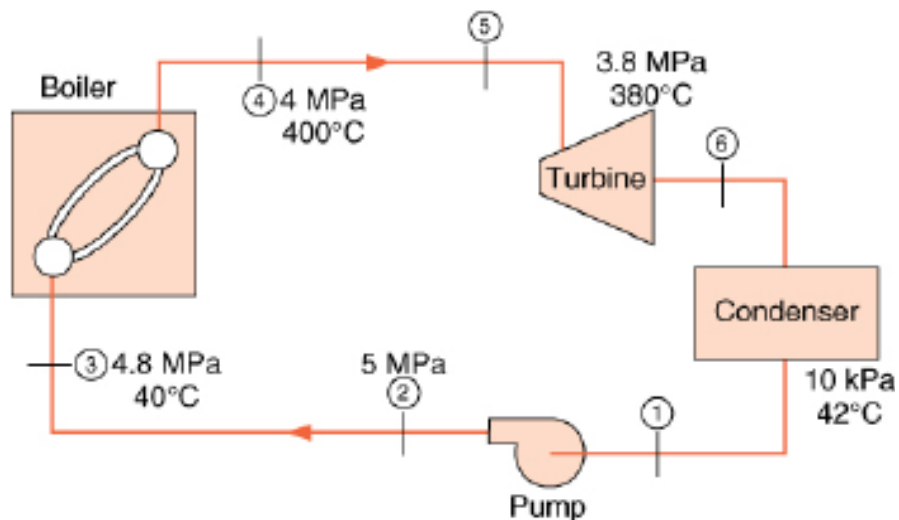

CRITERIA FOR THE COMPARISON OF CYCLES

The choice of power plant for a given purpose is determined largely by considerations of **operating cost** and **capital cost**. The former is primarily a function of overall efficiency of the plant, while the latter depends mainly on its size and complexity.

The Second Law tells us that even in the best power cycle, some heat must be rejected. The best form of cycle is one in which (i) all the heat supplied is transferred while the working fluid is at constant temperature T_H , and all the heat rejected from the working

fluid is at constant temperature T_L ; (ii) all processes are reversible. The efficiency of the such cycle is $\frac{T_H - T_L}{T_H}$, which is known as ideal cycle efficiency or Carnot efficiency.

However, all real processes are irreversible and irreversibility reduces cycle efficiency. Hence the ratio of actual cycle efficiency to ideal cycle efficiency, i.e. the efficiency ratio is one measure of comparison. Some cycles are more sensitive to irreversibilities than others. That is, two cycles may have the same ideal cycle efficiencies, but allowing for the process efficiencies, their actual cycle efficiencies may be markedly different. Hence, **Work Ratio** r_w is a criterion, which indicates the cycle sensitiveness to the irreversibilities. Any cycle consists of both positive (turbine work) and negative (pump work) work. The work ratio r_w is defined as the ratio of net work to the positive work done in the cycle. That is

$$r_w = \frac{W_T - w_P}{W_T}$$

If r_w is near unity, then the effect of irreversibility on the cycle efficiency is less. However, if r_w is slightly greater than zero, quite a small amount of component inefficiencies is sufficient to reduce the network output to zero thereby reducing the actual cycle efficiency to zero.

Hence, we can say that a high ideal cycle efficiency together with high work ratio provides a reliable indication that a real power plant will have a good overall efficiency.

The next consideration is some criterion which will indicate the relative size of plant for a given power output. In general, the size of component depends on the amount of working fluid, which has to be passed through them. A direct indication of relative sizes of steam power plant is therefore provided by the **Specific Steam Consumption** (ssc) i.e. mass flow of steam required per unit power output. If W is the net work output in kJ/kg, then ssc can be found from

$$\text{ssc} = \frac{1}{W} \left[\frac{\text{kg}}{\text{kJ}} \text{ or } \frac{\text{kg}}{\text{kWs}} \right] \times 3600 \left[\frac{\text{s}}{\text{h}} \right] = \frac{3600}{W} \left[\frac{\text{kg}}{\text{kWh}} \right]$$

Gas Power / Air Standard Cycles.

For small power plants, gas is ideally preferred as the working fluid. The gasoline engines, diesel engines and gas turbines are common examples.

The analysis of the air-standard cycle is based on the assumptions that are far from real. In actual internal combustion (IC) engines, chemical reaction occurs inside the engine cylinder as a result of combustion of air-fuel mixture and. The IC engines are actually operated on Open cycles in which the working fluid does not go through a cycle. The accurate analysis of IC engine is very complicated. However, it is advantageous to analyse the performance of an ideal closed cycle that closely approximates the real cycle. One such approach is air-standard cycle, which is based on certain assumptions. The assumptions for idealized air-standard cycles are:

- 1) The working fluid, air, is assumed to be an ideal gas. The equation of state is given by the equation $p v = R T$ and the specific heats are assumed to be constant.
- 2) All processes that constitute the cycle are reversible.
- 3) No chemical reaction occurs during the cycle. Heat is supplied from a high temperature reservoir (instead of chemical reaction) and some heat is rejected to the low temperature reservoir during the cycle.
- 4) The mass of air within the system remains constant throughout the cycle.
- 5) Heat losses from the system to the atmosphere are assumed to be zero.

In this we shall discuss about the Brayton cycle, Otto cycle and Diesel cycle.

BRAYTON CYCLE

The Brayton cycle is widely used as the basis for the operation of Gas turbine.

A schematic diagram of a simple gas turbine (open cycle) and the corresponding p-v and T-s diagrams are shown below.

Air is drawn from the atmosphere into compressor, where it is compressed reversibly and adiabatically. The relative high pressure air is then used in burning the fuel in the combustion chamber. The air-fuel ratio quite high (about 60:1) to limit the temperature burnt gases entering the turbine. The gases then expand isentropically in the turbine. A

portion of the work obtained from the turbine is utilised to drive the compressor and the auxiliary drive and the rest of the power output is the net power of the gas turbine plant.

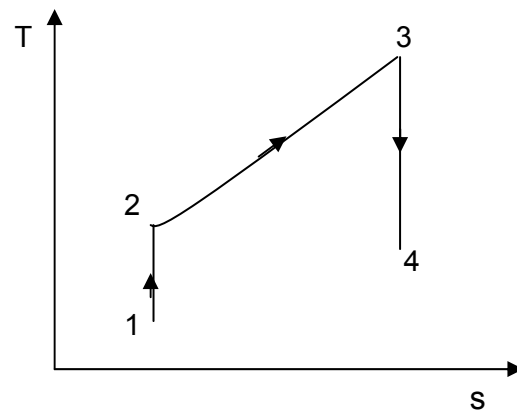
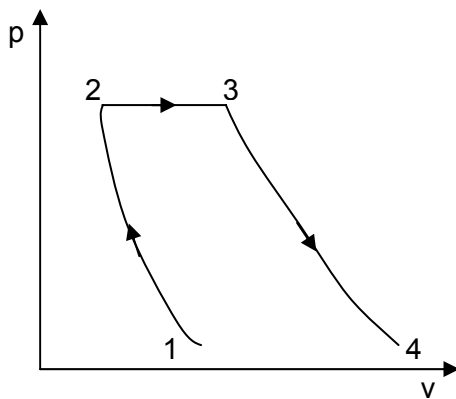
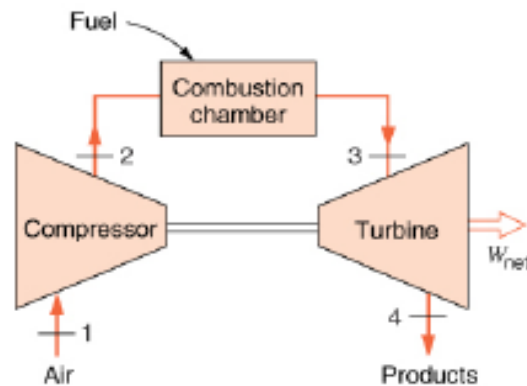

Simple gas turbine Brayton cycle with closed cycle consists of

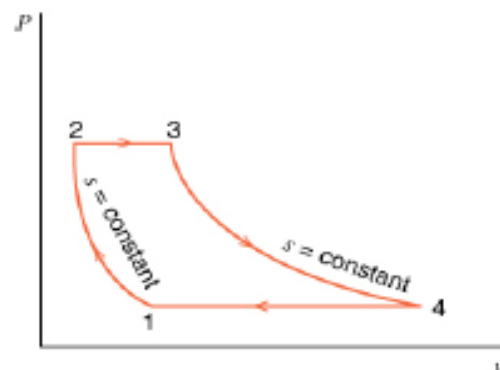
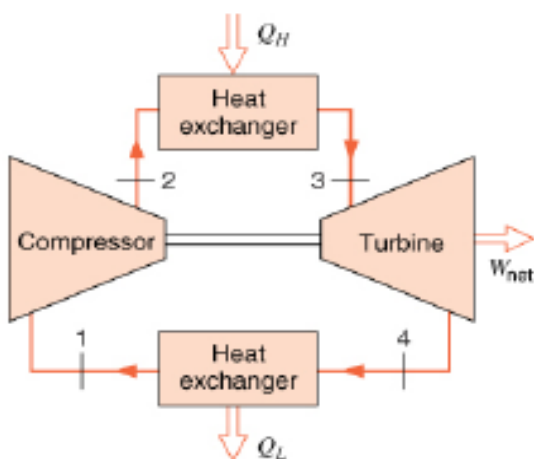

- 1 – 2 Isentropic compression in the compressor.
- 2 – 3 Constant pressure heat addition.

- 3 – 4 Isentropic expansion in the turbine.
 4 – 1 Constant pressure heat rejection.

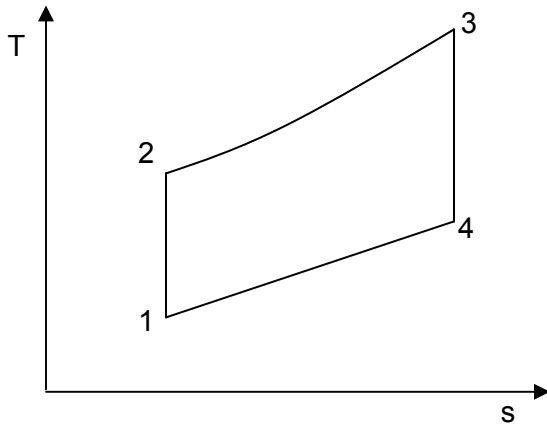

Assuming constant specific heats, the thermal efficiency of the cycle

$$\eta_{\text{th}} = 1 - \frac{Q_L}{Q_H}$$

$$\text{or } \eta_{\text{th}} = 1 - \frac{h_4 - h_1}{h_3 - h_2}$$

$$= 1 - \frac{C_P (T_4 - T_1)}{C_P (T_3 - T_2)}$$

The thermal efficiency can be written as

$$\eta_{\text{th}} = 1 - \frac{T_4 - T_1}{T_3 - T_2}$$

$$= 1 - \frac{T_1 \left[\frac{T_4}{T_1} - 1 \right]}{T_2 \left[\frac{T_3}{T_2} - 1 \right]}$$

$$\text{Now } \frac{T_2}{T_1} = \left(\frac{p_2}{p_1} \right)^{\frac{\gamma-1}{\gamma}} \quad \text{and} \quad \frac{T_3}{T_4} = \left(\frac{p_3}{p_4} \right)^{\frac{\gamma-1}{\gamma}}$$

Since, $p_2 = p_3$ and $p_1 = p_4$, it follows

$$\frac{T_2}{T_1} = \frac{T_3}{T_4} \quad \text{or} \quad \frac{T_4}{T_1} = \frac{T_3}{T_2}$$

$$\text{Hence, } \eta_{\text{th}} = 1 - \frac{T_1}{T_2} = 1 - \frac{1}{\left(\frac{p_2}{p_1} \right)^{\frac{\gamma-1}{\gamma}}} = 1 - \left(\frac{1}{r_p} \right)^{\frac{\gamma-1}{\gamma}}$$

Where r_p is the pressure ratio.

It can be seen that increasing the pressure ratio can increase the efficiency of the Brayton cycle.

Effect of Pressure Ratio

As mentioned above, the thermal efficiency of the Brayton cycle depends on the pressure ratio and the ratio of specific heat. For air, $\gamma = 1.4$ and the efficiency vs. pressure ratio plot is shown below.

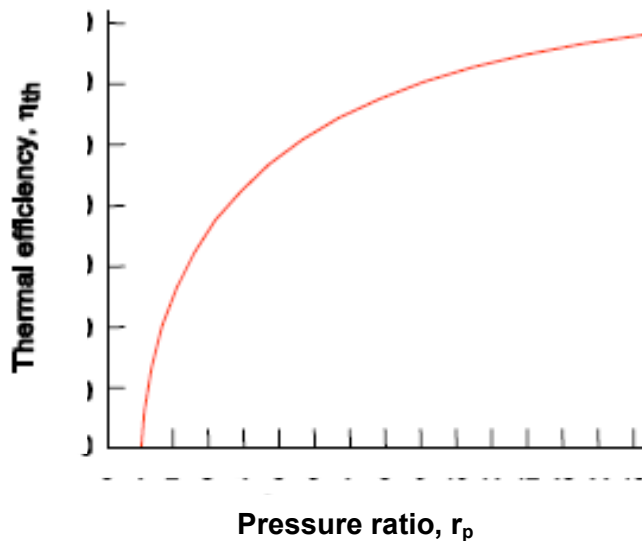

The highest temperature of the cycle occurs at the end of combustion process (state 3) and the maximum temperature that the turbine blades can withstand limits it. This also limits the pressure ratio that can be used for the cycle. In gas turbine cycle, T_1 is the temperature of the atmosphere and T_3 is the temperature of the burnt gases entering the turbine. Both these temperatures are fixed, first

by ambient conditions and second by metallurgical conditions. Between these two extreme values of temperatures, there exists an optimum pressure ratio for which the net work output of the cycle is maximum.

The net work output of the turbine is given by

$$\begin{aligned} W_n &= C_p (T_3 - T_4) - C_p (T_2 - T_1) \\ &= -C_p T_3 \left[\frac{T_4}{T_3} - 1 \right] - C_p T_1 \left[\frac{T_2}{T_1} - 1 \right] \end{aligned}$$

Now $\frac{T_4}{T_1} = \frac{T_3}{T_2}$ or $\frac{T_4}{T_3} = \frac{T_1}{T_2}$

$$\begin{aligned}
\therefore W_n &= -C_p T_3 \left[\frac{T_1}{T_2} - 1 \right] - C_p T_1 \left[\frac{T_2}{T_1} - 1 \right] \\
&= -C_p T_3 \left[\frac{1}{\left(\frac{p_2}{p_1} \right)^{\frac{\gamma-1}{\gamma}}} - 1 \right] - C_p T_1 \left[\left(\frac{p_2}{p_1} \right)^{\frac{\gamma-1}{\gamma}} - 1 \right] \\
&= -C_p T_3 \left[\frac{1}{(r_p)^{\frac{\gamma-1}{\gamma}}} - 1 \right] - C_p T_1 \left[(r_p)^{\frac{\gamma-1}{\gamma}} - 1 \right]
\end{aligned}$$

The optimum pressure ratio is obtained by differentiating the net work with respect to pressure ratio, r_p and putting the derivative as zero.

Let $\frac{\gamma-1}{\gamma} = n$

$$W_n = -C_p T_3 \left[\frac{1}{(r_p)^n} - 1 \right] - C_p T_1 \left[(r_p)^n - 1 \right]$$

or $\frac{dW_n}{dr_p} = -C_p T_3 \left[-n r_p^{-n-1} \right] - C_p T_1 \left[n r_p^{n-1} \right]$

or $0 = C_p T_3 n r_p^{-n-1} - C_p T_1 n r_p^{n-1}$

or $T_3 n r_p^{-n-1} = T_1 n r_p^{n-1}$

or $r_p^{(-n-1)-(n-1)} = \frac{T_1}{T_3}$

or $r_p^{-2n} = \frac{T_1}{T_3}$

or $r_p^{2n} = \frac{T_3}{T_1}$

i.e. $(r_p)_{\text{optimum}} = \left(\frac{T_3}{T_1} \right)^{\frac{1}{2n}}$

or $(r_p)_{\text{optimum}} = \left(\frac{T_3}{T_1} \right)^{\frac{\gamma}{2(\gamma-1)}}$

The maximum work is given by

$$\begin{aligned} W_{\max} &= -C_P T_3 \left[\left(\frac{T_1}{T_3} \right)^{\frac{1}{2}} - 1 \right] - C_P T_1 \left[\left(\frac{T_3}{T_1} \right)^{\frac{1}{2}} - 1 \right] \\ &= C_P \left[T_3 - 2(T_1 T_3)^{\frac{1}{2}} + T_1 \right] \\ &= C_P \left[\sqrt{T_3} - \sqrt{T_1} \right]^2 \end{aligned}$$

i.e. $W_{\max} = C_P \left[\sqrt{T_{\max}} - \sqrt{T_{\min}} \right]^2$

Effect of Reversibility

In an ideal gas turbine plant, the compression and expansion processes are isentropic and there is no pressure drop in the combustion chamber and heat exchanger. But because of irreversibilities associated with the compressor and the turbine and because of the pressure drop in the actual flow passages and combustion chamber, the actual gas turbine plant cycle differs from the ideal one.

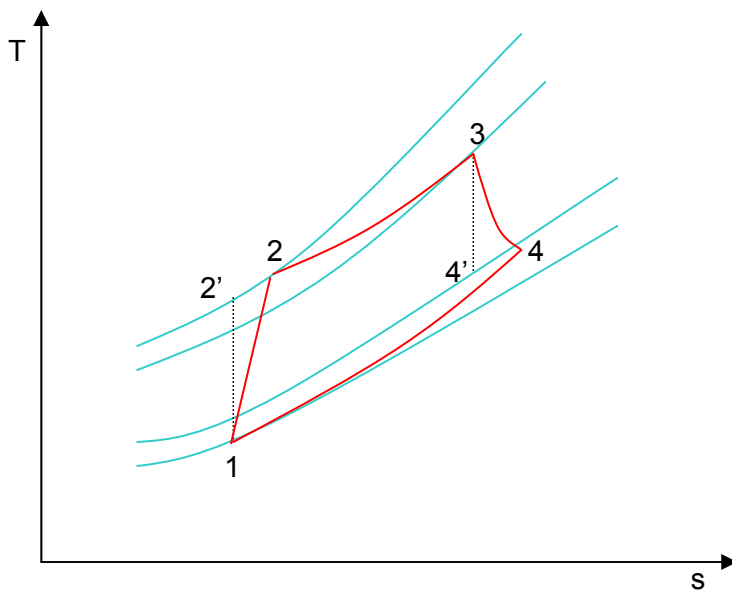

Compressor efficiency

$$\eta_c = \frac{h_2' - h_1}{h_2 - h_1}$$

Turbine efficiency

$$\eta_T = \frac{h_3 - h_4}{h_3 - h_4'}$$

Regenerative Brayton Cycle

The temperature of the exhaust gases of simple gas turbine is higher than the temperature of air after compression. If the heat energy in the exhaust gases instead of getting dissipated in the atmosphere is used in heating air after compression, it will reduce the energy requirement from the fuel, thereby increasing the efficiency of the cycle.

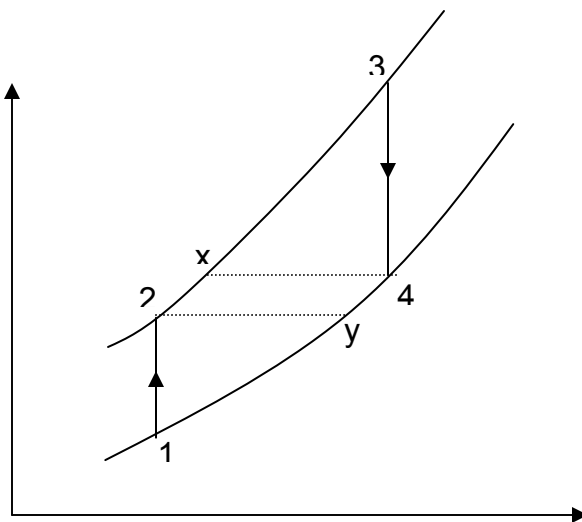
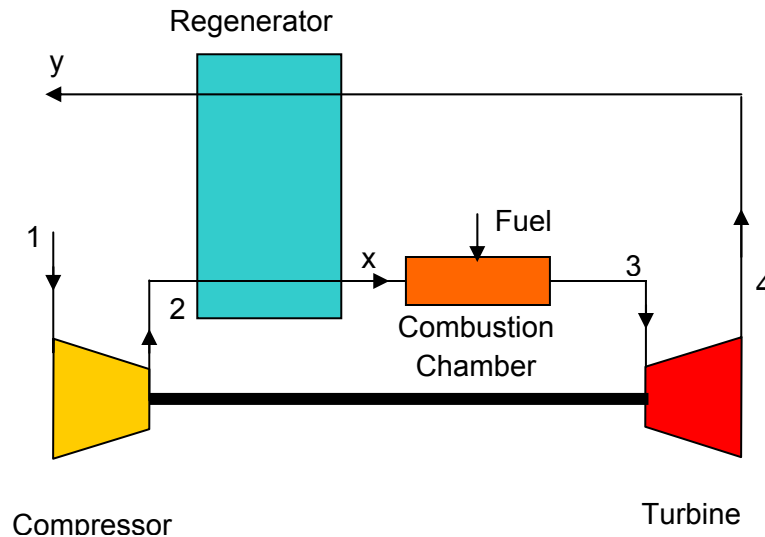

Air is drawn from the atmosphere into compressor and compressed isentropically to state 2. It is then heated at constant pressure in the regenerator to state x by hot burnt gases from the turbine. Since the temperature of air is increased before it reaches the combustion chamber, less amount of fuel will be required to attain the designed turbine inlet temperature of the products of combustion. After the combustion at constant pressure in the combustion chamber, the gas enters the turbine at state 3 and expands to state 4 isentropically. It then enters the counter-flow regenerator, where it gives up a portion of its heat energy to the compressed air from the compressor and leaves the regenerator at state y. In the

ideal cycle, the temperature of the compressed air leaving the regenerator is equal to the temperature of the burnt gases leaving the turbine, i.e. $T_x = T_4$. But in practice, the temperature of the compressed air leaving the regenerator is less than T_x .

The effectiveness of the regenerator is given by the ratio of the increase in enthalpy of the working fluid flowing through the regenerator to the maximum available enthalpy difference.

The effectiveness of regenerator is given by

$$\eta_R = \frac{h_{x'} - h_2}{h_x - h_2}$$

Assuming constant specific heat

$$\eta_R = \frac{T_{x'} - T_2}{T_x - T_2}$$

The thermal efficiency of an ideal gas turbine cycle with regenerator is

$$\eta_{th} = 1 - \frac{Q_L}{Q_H} = 1 - \frac{h_y - h_1}{h_3 - h_x} = 1 - \frac{T_y - T_1}{T_3 - T_x}$$

Since for ideal condition

$$T_x = T_4 \quad \text{and} \quad T_y = T_2$$

Therefore,

$$\eta_{th} = \frac{T_2 - T_1}{T_3 - T_4} = 1 - \frac{T_1 \left[\frac{T_2}{T_1} - 1 \right]}{T_3 \left[1 - \frac{T_4}{T_3} \right]}$$

Since

$$\frac{T_2}{T_1} = \left(\frac{p_2}{p_1} \right)^{\frac{\gamma-1}{\gamma}} \quad \text{and} \quad \frac{T_4}{T_3} = \left(\frac{p_4}{p_3} \right)^{\frac{\gamma-1}{\gamma}} = \left(\frac{p_1}{p_2} \right)^{\frac{\gamma-1}{\gamma}}$$

\therefore

$$\eta_{th} = 1 - \frac{T_1 \left[\left(\frac{p_2}{p_1} \right)^{\frac{\gamma-1}{\gamma}} - 1 \right]}{T_3 \left[1 - \frac{1}{\left(\frac{p_2}{p_1} \right)^{\frac{\gamma-1}{\gamma}}} \right]}$$

$$= 1 - \frac{T_1}{T_3} \left(\frac{p_2}{p_1} \right)^{\frac{\gamma-1}{\gamma}}$$

So the thermal efficiency of an ideal regenerative gas turbine cycle depends not only on the pressure ratio but also on the ratio of two extreme temperatures. In this case, lower the pressure ratio, higher the efficiency, the maximum value being $\frac{T_3 - T_1}{T_3}$ when $r_p = 1$.

This is the Carnot cycle efficiency based upon maximum and minimum temperatures of the cycle.

Intercooling and Reheating

The addition of regenerator improves the ideal efficiency but does not improve the work ratio. The latter may be reduced by reducing the compressor work or increasing the turbine work.

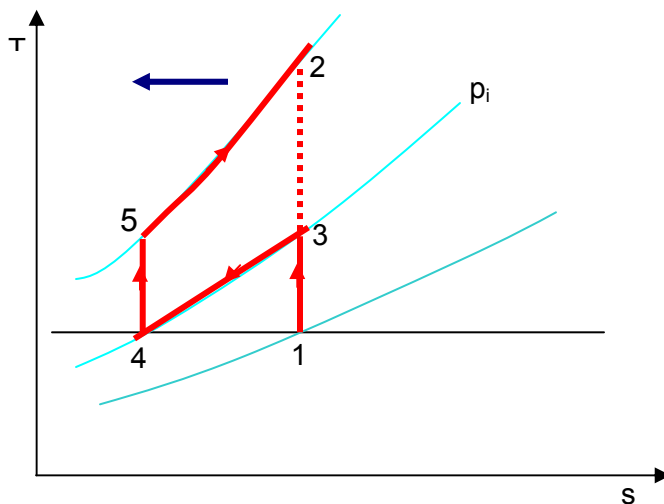

Consider the compressor work first. The curvature of the constant pressure lines on T-s diagram is such that the vertical distance between them reduces as we go towards the left (shown by the arrow). Therefore, further to the left the compression process 1-2 takes place, smaller is the work required to drive the compressor. State 1 is determined by

the atmospheric pressure and temperature. But if the compression is carried out in two stages, 1-3 and 4-5 with the air is being cooled at constant intermediate pressure p_i between the stages; some reduction of compression work can be achieved. The sum of temperature rises $(T_3 - T_1)$ and $(T_5 - T_4)$ will be clearly less than $(T_2 - T_1)$. Ideally, it is possible to cool the air to atmospheric condition i.e. $T_4 = T_1$, and in this case Intercooling is complete.

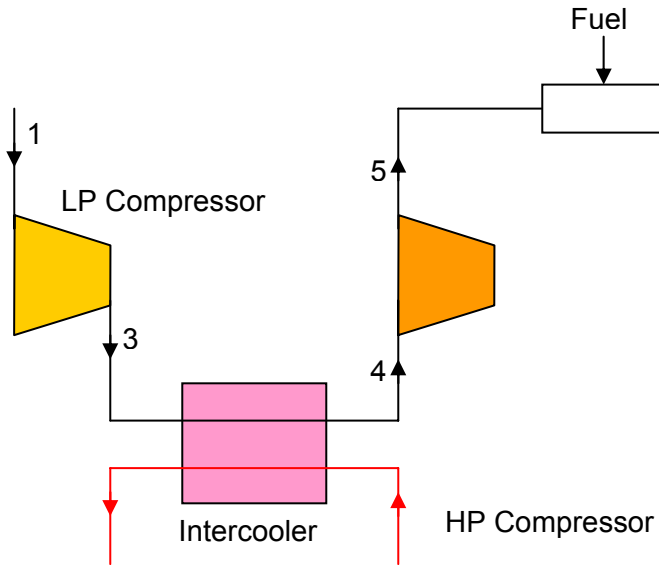

With isentropic compression and complete Intercooling, the compressor work is given by

$$\begin{aligned}
 W &= -C_p (T_3 - T_1) - C_p (T_5 - T_4) \\
 &= -C_p T_1 \left\{ \left(\frac{p_i}{p_1} \right)^{\frac{\gamma-1}{\gamma}} - 1 \right\} \\
 &\quad - C_p T_1 \left\{ \left(\frac{p_2}{p_i} \right)^{\frac{\gamma-1}{\gamma}} - 1 \right\}
 \end{aligned}$$

The saving in work will depend on the choice of intermediate

Intercooling pressure p_i . By equating $\frac{dW}{dp_i}$ to zero the condition for minimum work is given by

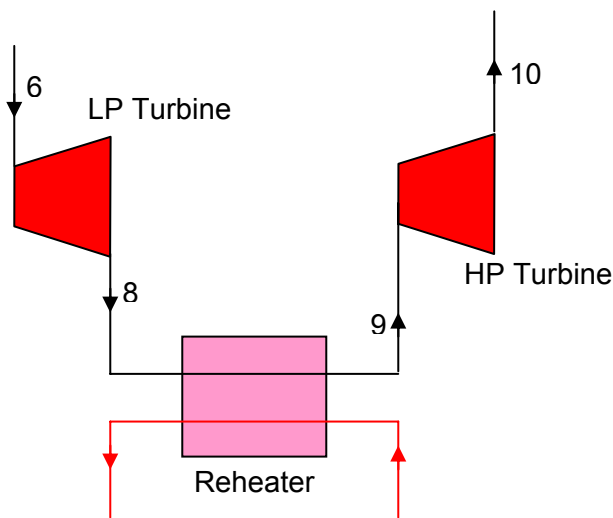

$$p_i = \sqrt{p_1 p_2}$$

Hence,

$$\frac{p_i}{p_1} = \frac{p_2}{p_i} = r_{p_i}$$

and

$$r_{p_i} = \sqrt{\frac{p_2}{p_1}} = \sqrt{r_p}$$

Thus for minimum compressor work, the compression ratio and work inputs for two stages are equal. The compression work can further be reduced by increasing the number of stages and intercoolers. But the additional complexity and cost make more than three stages uneconomic. Similarly, it can be shown that the work output from the turbine is increased by multi-stage expansion

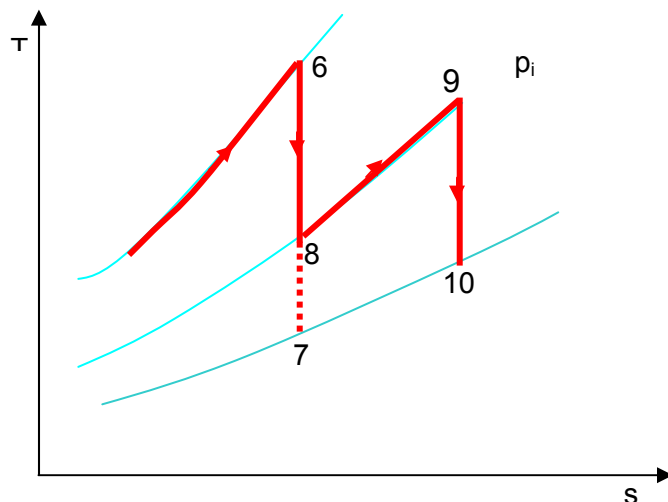

The thermal efficiency is given by

$$\eta_{\text{th}} = 1 - \frac{Q_L}{Q_H} = 1 - \frac{(h_{10} - h_1) + (h_2 - h_3)}{(h_6 - h_5) + (h_8 - h_7)}$$

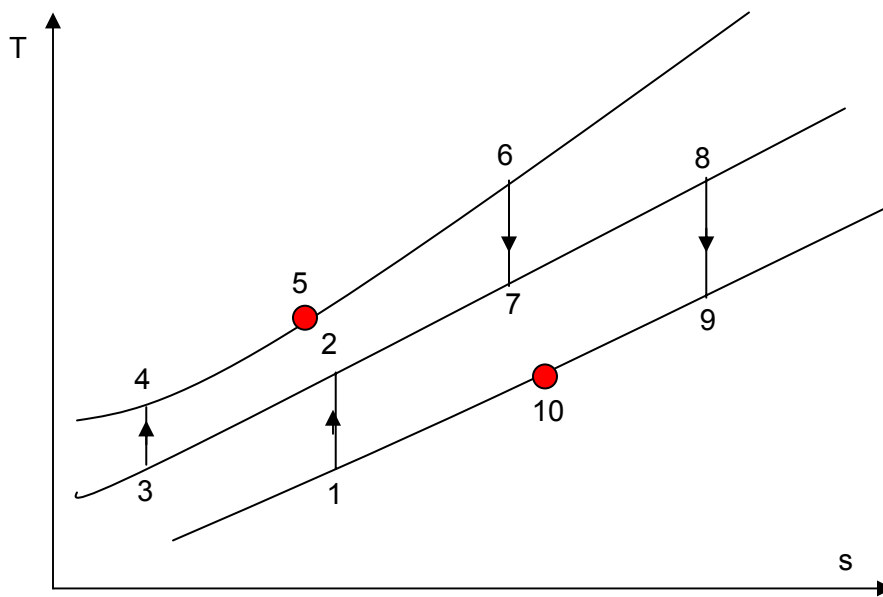

OTTO CYCLE

The air standard Otto Cycle is an idealised cycle which closely approximates the operation of Spark Ignition (SI) Engine.

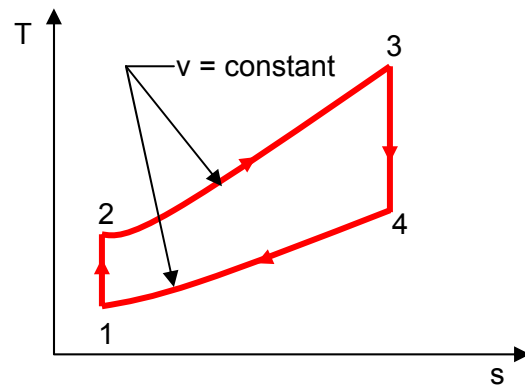
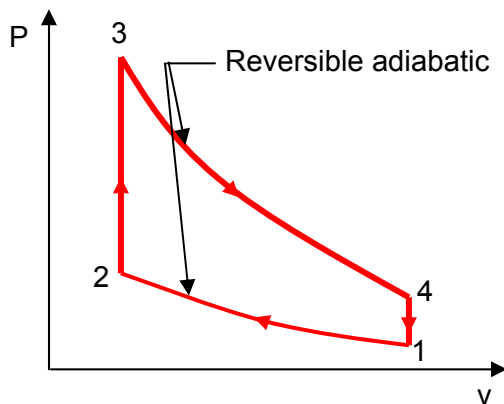

Process 1-2 is reversible adiabatic (isentropic) compression of air when the piston moves from crank-end dead centre (BDC) to cylinder head dead centre (TDC). During

the process 2-3, heat is transferred reversibly to the system at constant volume (this process corresponds to the spark ignition of the actual engine). The curve 3-4 represents the reversible adiabatic expansion process when piston moves from TDC to BDC and the curve 4-1 represents the heat rejected by the system reversibly at constant volume.

The thermal efficiency

$$\begin{aligned}\eta_{\text{th}} &= \frac{Q_{\text{added}} - Q_{\text{rejected}}}{Q_{\text{added}}} = 1 - \frac{Q_{\text{rejected}}}{Q_{\text{added}}} \\ &= 1 - \frac{u_4 - u_1}{u_3 - u_2} = 1 - \frac{C_v (T_4 - T_1)}{C_v (T_3 - T_2)} \\ &= 1 - \frac{T_4 - T_1}{T_3 - T_2}\end{aligned}$$

Chapter 4 Ideal And Real Gases And Thermodynamic Relations

GAS MIXTURES

Pure substance is defined as a substance which means that it is homogeneous and unchanging in chemical composition.

COMPOSITION OF A GAS MIXTURE:

MASS AND MOLE FRACTIONS

To determine the properties of a mixture, we need to know the composition of the mixture as well as the properties of the individual components. There are two ways to describe the composition of a mixture: either by specifying the number of moles of each component, called molar analysis, or by specifying the mass of each component, called gravimetric analysis.

Consider a gas mixture composed of k components. The mass of the mixture m_m is the sum of the masses of the individual components, and the mole number of the mixture N_m is the sum of the mole numbers of the individual components.

$$m_m = \sum_{i=1}^k m_i \quad \text{and} \quad N_m = \sum_{i=1}^k N_i \quad \dots\dots\dots(1)$$

The ratio of the mass of a component to the mass of the mixture is called the mass fraction mf , and the ratio of the mole number of a component to the mole number of the mixture is called the mole fraction

$$mf_i = \frac{m_i}{m_m} \quad \text{and} \quad y_i = \frac{N_i}{N_m} \quad \dots\dots\dots(2)$$

Dividing (1) by m_m or (2) by N_m , we can easily show that the sum of the mass fractions or mole fractions for a mixture is equal to 1

$$\sum_{i=1}^k mf_i = 1 \quad \text{and} \quad \sum_{i=1}^k y_i = 1 \quad \dots\dots\dots(3)$$

The mass of a substance can be expressed in terms of the mole number N and molar mass M of the substance as $m = NM$. Then the apparent (or average) molar mass and the gas constant of a mixture can be expressed as

$$M_m = \frac{m_m}{N_m} = \frac{\sum m_i}{N_m} = \frac{\sum N_i M_i}{N_m} = \sum_{i=1}^k y_i M_i \quad \text{and} \quad R_m = \frac{R_u}{M_m} \quad \dots\dots\dots(4)$$

The molar mass of a mixture can also be expressed as

$$M_m = \frac{m_m}{N_m} = \frac{m_m}{\sum m_i / M_i} = \frac{1}{\sum m_i / (m_m M_i)} = \frac{1}{\sum_{i=1}^k \frac{mf_i}{M_i}} \quad \dots\dots\dots(5)$$

Mass and mole fractions of a mixture are related by

$$mf_i = \frac{m_i}{m_m} = \frac{N_i M_i}{N_m M_m} = y_i \frac{M_i}{M_m} \quad \dots\dots\dots(6)$$

EXAMPLE 13–1 Mass and Mole Fractions of a Gas Mixture

Consider a gas mixture that consists of 3 kg of O_2 , 5 kg of N_2 , and 12 kg of CH_4 , as shown in Fig. 13–4. Determine (a) the mass fraction of each component, (b) the mole fraction of each component, and (c) the average molar mass and gas constant of the mixture.

Solution The masses of components of a gas mixture are given. The mass fractions, the mole fractions, the molar mass, and the gas constant of the mixture are to be determined.

Analysis (a) The total mass of the mixture is

$$m_m = m_{O_2} + m_{N_2} + m_{CH_4} = 3 + 5 + 12 = 20 \text{ kg}$$

Then the mass fraction of each component becomes

$$mf_{O_2} = \frac{m_{O_2}}{m_m} = \frac{3 \text{ kg}}{20 \text{ kg}} = \mathbf{0.15}$$

$$mf_{N_2} = \frac{m_{N_2}}{m_m} = \frac{5 \text{ kg}}{20 \text{ kg}} = \mathbf{0.25}$$

$$mf_{CH_4} = \frac{m_{CH_4}}{m_m} = \frac{12 \text{ kg}}{20 \text{ kg}} = \mathbf{0.60}$$

(b) To find the mole fractions, we need to determine the mole numbers of each component first:

$$N_{\text{O}_2} = \frac{m_{\text{O}_2}}{M_{\text{O}_2}} = \frac{3 \text{ kg}}{32 \text{ kg/kmol}} = 0.094 \text{ kmol}$$

$$N_{\text{N}_2} = \frac{m_{\text{N}_2}}{M_{\text{N}_2}} = \frac{5 \text{ kg}}{28 \text{ kg/kmol}} = 0.179 \text{ kmol}$$

$$N_{\text{CH}_4} = \frac{m_{\text{CH}_4}}{M_{\text{CH}_4}} = \frac{12 \text{ kg}}{16 \text{ kg/kmol}} = 0.750 \text{ kmol}$$

Thus,

$$N_m = N_{\text{O}_2} + N_{\text{N}_2} + N_{\text{CH}_4} = 0.094 + 0.179 + 0.750 = 1.023 \text{ kmol}$$

and

$$y_{\text{O}_2} = \frac{N_{\text{O}_2}}{N_m} = \frac{0.094 \text{ kmol}}{1.023 \text{ kmol}} = \mathbf{0.092}$$

$$y_{\text{N}_2} = \frac{N_{\text{N}_2}}{N_m} = \frac{0.179 \text{ kmol}}{1.023 \text{ kmol}} = \mathbf{0.175}$$

$$y_{\text{CH}_4} = \frac{N_{\text{CH}_4}}{N_m} = \frac{0.750 \text{ kmol}}{1.023 \text{ kmol}} = \mathbf{0.733}$$

(c) The average molar mass and gas constant of the mixture are determined from their definitions,

$$M_m = \frac{m_m}{N_m} = \frac{20 \text{ kg}}{1.023 \text{ kmol}} = \mathbf{19.6 \text{ kg/kmol}}$$

or

$$\begin{aligned} M_m &= \sum y_i M_i = y_{\text{O}_2} M_{\text{O}_2} + y_{\text{N}_2} M_{\text{N}_2} + y_{\text{CH}_4} M_{\text{CH}_4} \\ &= (0.092)(32) + (0.175)(28) + (0.733)(16) \\ &= 19.6 \text{ kg/kmol} \end{aligned}$$

Also,

$$R_m = \frac{R_u}{M_m} = \frac{8.314 \text{ kJ}/(\text{kmol} \cdot \text{K})}{19.6 \text{ kg/kmol}} = \mathbf{0.424 \text{ kJ/kg} \cdot \text{K}}$$

Discussion When mass fractions are available, the molar mass and mole fractions could also be determined directly from Eqs. 13–4 and 13–5.

P-v-T BEHAVIOR OF GAS MIXTURES:

IDEAL AND REAL GASES

An ideal gas is defined as a gas whose molecules are spaced far apart so that the behavior of a molecule is not influenced by the presence of other molecules—a situation encountered at low densities. We also mentioned that real gases approximate this behavior closely when they are at a low pressure or high temperature relative to their critical-point values. The P-v-T behavior of an ideal gas is expressed by the simple relation $Pv = RT$, which is called the ideal-gas equation of state. The P-v-T behavior of real gases is expressed by more complex equations of state or by $Pv = ZRT$, where Z is the compressibility factor.

When two or more ideal gases are mixed, the behavior of a molecule normally is not influenced by the presence of other similar or dissimilar molecules, and therefore a nonreacting mixture of ideal gases also behaves as an ideal gas. Air, for example, is conveniently treated as an ideal gas in the range where nitrogen and oxygen behave as ideal gases. When a gas mixture consists of real (nonideal) gases, however, the prediction of the P-v-T behavior of the mixture becomes rather involved.

The prediction of the P-v-T behavior of gas mixtures is usually based on two models: Dalton's law of additive pressures and Amagat's law of additive volumes. Both models are described and discussed below.

Dalton's law of additive pressures:

Dalton's law (also called **Dalton's law of partial pressures**) states that the total pressure exerted by a gaseous mixture is equal to the sum of the partial pressures of each individual component in a gas mixture. This empirical law was observed by John Dalton in 1801 and is related to the ideal gas laws.

Mathematically, the pressure of a mixture of gases can be defined as the summation

$$P_{total} = \sum_{i=1}^n p_i \quad \text{or} \quad P_{total} = p_1 + p_2 + \cdots + p_n$$

where p_1 , p_2 , p_n represent the partial pressure of each component.

It is assumed that the gases do not react with each other.

$$P_i = P_{total}x_i$$

where x_i = the mole fraction of the i-th component in the total mixture of m components .

The relationship below provides a way to determine the volume based concentration of any individual gaseous component.

$$P_i = \frac{P_{total}C_i}{1,000,000}$$

where: C_i = is the concentration of the ith component expressed in ppm.

Dalton's law is not exactly followed by real gases. Those deviations are considerably large at high pressures. In such conditions, the volume occupied by the molecules can become significant compared to the free space between them. Moreover, the short average distances between molecules raises the intensity of intermolecular forces between gas molecules enough to substantially change the pressure exerted by them. Neither of those effects are considered by the ideal gas model.

Amagat's law of additive volumes:

Amagat's law or the **Law of Partial Volumes** of 1880 describes the behaviour and properties of mixtures of ideal (as well as some cases of non-ideal) gases. Of use in chemistry and thermodynamics, Amagat's law states that the volume V_m of a gas mixture is equal to the sum of volumes V_i of the K component gases, if the temperature T and the pressure p remain the same: ^[1]

$$V_m(T, p) = \sum_{i=1}^K V_i(T, p)$$

This is the experimental expression of volume as an extensive quantity. It is named after Emile Amagat.

Both Amagat's and Dalton's Law predict the properties of gas mixtures. Their predictions are the same for ideal gases. However, for real (non-ideal) gases, the results differ.^[2] Dalton's Law of Partial Pressures assumes that the gases in the mixture are non-interacting (with each other) and each gas independently applies its own **pressure**, the sum of which is the total pressure. Amagat's Law assumes that the **volumes** of each component gas (same temperature and pressure) are additive; the interactions of the different gases are the same as the average interactions of the components.

MIXING OF IDEAL GASES

Thermodynamics of Mixing of Ideal Gases

$$\mu_A = \mu_A^o + RT \ln \frac{P}{P^o}$$

P, T n _A	P, T n _B
------------------------	------------------------

before: $G_i = \mu_A n_A + \mu_B n_B$

$$= n_A \left(\mu_A^o + RT \ln \frac{P}{P^o} \right) + n_B \left(\mu_B^o + RT \ln \frac{P}{P^o} \right)$$

after: $G_f = \mu_A n_A + \mu_B n_B$ Partial pressures: P_A and P_B

$$= n_A \left(\mu_A^o + RT \ln \frac{P_A}{P^o} \right) + n_B \left(\mu_B^o + RT \ln \frac{P_B}{P^o} \right)$$

$$\Delta_{\text{mix}}G = G_f - G_i = n_A \left(RT \ln \frac{P_A}{P^o} - RT \ln \frac{P}{P^o} \right) + n_B \left(RT \ln \frac{P_B}{P^o} - RT \ln \frac{P}{P^o} \right)$$

$$\Delta_{\text{mix}}G = n_A \left(RT \ln \frac{P_A}{P} \right) + n_B \left(RT \ln \frac{P_B}{P} \right)$$

$$P_A = y_A P \quad P_B = y_B P \quad y_A = n_A/n_{\text{tot}} \quad n_{\text{tot}} = n_A + n_B$$

$$\Delta_{\text{mix}}G = n_{\text{tot}} RT \left(\frac{n_A}{n_{\text{tot}}} \ln \frac{P_A}{P} + \frac{n_B}{n_{\text{tot}}} \ln \frac{P_B}{P} \right)$$

$$\Delta_{\text{mix}}G = n_{\text{tot}} RT (y_A \ln y_A + y_B \ln y_B)$$

$$\Delta_{\text{mix}}S = - \left(\frac{\partial \Delta_{\text{mix}}G}{\partial T} \right)_{P, n_A, n_B} = - n_{\text{tot}} R (y_A \ln y_A + y_B \ln y_B)$$

$$\Delta_{\text{mix}}G = \Delta_{\text{mix}}H - T \Delta_{\text{mix}}S \quad \Delta_{\text{mix}}H = 0$$

$$\Delta_{\text{mix}}G = n_{\text{tot}} RT \sum_{\text{all components } i} y_i \ln y_i$$

$$\Delta_{\text{mix}}S = - n_{\text{tot}} R \sum y_i \ln y_i$$

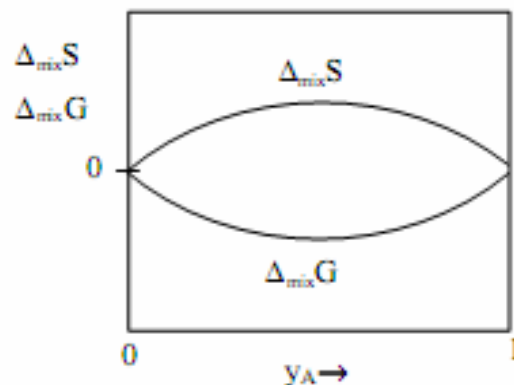

Ideal gas

An **ideal gas** is a theoretical gas composed of a set of randomly-moving point particles that interact only through elastic collisions. The ideal gas concept is useful because it obeys the ideal gas law, a simplified equation of state, and is amenable to analysis under statistical mechanics.

At normal ambient conditions such as standard temperature and pressure, most real gases behave qualitatively like an ideal gas. Generally, deviation from an ideal gas tends to decrease with higher temperature and lower density, as the work performed by intermolecular forces becomes less significant compared with the particles' kinetic energy, and the size of the molecules becomes less significant compared to the empty space between them.

The ideal gas model tends to fail at lower temperatures or higher pressures, when intermolecular forces and molecular size become important. At some point of low temperature and high pressure, real gases undergo a phase transition, such as to a liquid or a solid. The model of an ideal gas, however, does not describe or allow phase transitions. These must be modeled by more complex equations of state.

The ideal gas model has been explored in both the Newtonian dynamics (as in "kinetic theory") and in quantum mechanics (as a "gas in a box"). The Ideal Gas model has also been used to model the behavior of electrons in a metal (in the Drude model and the free electron model), and it is one of the most important models in statistical mechanics.

Classical thermodynamic ideal gas

The thermodynamic properties of an ideal gas can be described by two equations : The equation of state of a classical ideal gas is given by the ideal gas law.

$$PV = Nk_B T = nRT.$$

The internal energy at constant volume of an ideal gas is given by:

$$U = \hat{c}_V n R T = \hat{c}_V N k T$$

where:

- \hat{c}_V is a constant dependent on temperature (e.g. equal to 3/2 for a monoatomic gas for moderate temperatures)
- U is the internal energy
- P is the pressure
- V is the volume
- n is the chemical amount of the gas
- R is the gas constant ($8.314 \text{ J}\cdot\text{K}^{-1}\text{mol}^{-1}$ in SI units)
- T is the absolute temperature
- N is the number of gas particles
- k is the Boltzmann constant ($1.381 \times 10^{-23} \text{ J}\cdot\text{K}^{-1}$ in SI units)

The probability distribution of particles by velocity or energy is given by the Boltzmann distribution.

The ideal gas law is an extension of experimentally discovered gas laws. Real fluids at low density and high temperature approximate the behavior of a classical ideal gas. However, at lower temperatures or a higher density, a real fluid deviates strongly from the behavior of an ideal gas, particularly as it condenses from a gas into a liquid or solid. The deviation is expressed as a compressibility factor.

Heat capacity

The heat capacity at constant volume of an ideal gas is:

$$C_V = \left(\frac{\partial U}{\partial T} \right)_V = \hat{c}_V N k = \hat{c}_V n R.$$

It is seen that the constant \hat{c}_V is just the dimensionless heat capacity at constant volume. It is equal to half the number of degrees of freedom per particle. For moderate temperatures, the constant for a monoatomic gas is $\hat{c}_V = 3/2$ while for a diatomic gas it is $\hat{c}_V = 5/2$. It is seen that macroscopic measurements on heat capacity provide information on the microscopic structure of the molecules.

The heat capacity at constant pressure of an ideal gas is:

$$C_p = \left(\frac{\partial H}{\partial T} \right)_p = (\hat{c}_V + 1)Nk$$

where $H = U + pV$ is the enthalpy of the gas. It is seen that \hat{c}_p is also a constant and that the dimensionless heat capacities are related by:

$$\hat{c}_p - \hat{c}_V = 1.$$

Entropy

Using the results of thermodynamics only, we can go a long way in determining the expression for the entropy of an ideal gas. This is an important step since, according to the theory of thermodynamic potentials, of which the internal energy U is one, if we can express the entropy as a function of U and the volume V , then we will have a complete statement of the thermodynamic behavior of the ideal gas. We will be able to derive both the ideal gas law and the expression for internal energy from it.

Since the entropy is an exact differential, using the chain rule, the change in entropy when going from a reference state 0 to some other state with entropy S may be written as ΔS where:

$$\Delta S = \int_{S_0}^S dS = \int_{T_0}^T \left(\frac{\partial S}{\partial T} \right)_V dT + \int_{V_0}^V \left(\frac{\partial S}{\partial V} \right)_T dV$$

where the reference variables may be functions of the number of particles N . Using the definition of the heat capacity at constant volume for the first differential and the appropriate Maxwell relation for the second we have:

$$\Delta S = \int_{T_0}^T \frac{C_v}{T} dT + \int_{V_0}^V \left(\frac{\partial P}{\partial T} \right)_V dV$$

Expressing C_v in terms of \hat{c}_v as developed in the above section, differentiating the ideal gas equation of state, and integrating yields:

$$\Delta S = \hat{c}_v N k \ln \left(\frac{T}{T_0} \right) + N k \ln \left(\frac{V}{V_0} \right) = N k \ln \left(\frac{VT^{\hat{c}_v}}{f(N)} \right)$$

where all constants have been incorporated into the logarithm as $f(N)$ which is some function of the particle number N having the same dimensions as $VT^{\hat{c}_v}$ in order that the argument of the logarithm be dimensionless. We now impose the constraint that the entropy be extensive. This will mean that when the extensive parameters (V and N) are multiplied by a constant, the entropy will be multiplied by the same constant. Mathematically:

$$\Delta S(T, aV, aN) = a\Delta S(T, V, N)$$

From this we find an equation for the function $f(N)$

$$af(N) = f(aN)$$

Differentiating this with respect to a , setting a equal to unity, and then solving the differential equation yields $f(N)$:

$$f(N) = \phi N$$

where ϕ is some constant with the dimensions of $VT^{\hat{c}_v}/N$. Substituting into the equation for the change in entropy:

$$\frac{\Delta S}{Nk} = \ln \left(\frac{VT^{\hat{c}_v}}{N\phi} \right)$$

This is about as far as we can go using thermodynamics alone. Note that the above equation is flawed — as the temperature approaches zero, the entropy approaches negative infinity, in contradiction to the third law of thermodynamics. In the above "ideal" development, there is a critical point, not at absolute zero, at which the argument of the logarithm becomes unity, and the entropy becomes zero. This is unphysical. The above equation is a good approximation only when the argument of the logarithm is much larger than unity — the concept of an ideal gas breaks down at low values of V/N . Nevertheless, there will be a "best" value of the constant in the sense that the predicted entropy is as close as possible to the actual entropy, given the flawed assumption of ideality. It remained for quantum mechanics to introduce a reasonable value for the value of ϕ which yields the Sackur-Tetrode equation for the entropy of an ideal gas. It too suffers from a divergent entropy at absolute zero, but is a good approximation to an ideal gas over a large range of densities.

Equation Table for an Ideal Gas

Quantity	General Equation	Isobaric $\Delta p = 0$	Isochoric $\Delta V = 0$	Isothermal $\Delta T = 0$	Adiabatic $Q = 0$
Work W	$\delta W = p dV$	$p \Delta V$	0	$nRT \ln \frac{V_2}{V_1}$	$C_V (T_1 - T_2)$
Heat Capacity C	(as for real gas)	$C_p = \frac{5}{2} nR$	$C_V = \frac{3}{2} nR$		
Internal Energy ΔU	$\Delta U = \frac{3}{2} nR \Delta T$	$Q - W$ $Q_p - p \Delta V$	Q $C_V (T_2 - T_1)$	$Q = W$	$C_V (T_2 - T_1)$
Enthalpy ΔH	$H = U + pV$	$C_p (T_2 - T_1)$	$Q_V + V \Delta p$	0	$C_p (T_2 - T_1)$
Entropy ΔS	$ds = c_p \frac{dT}{T} - R \frac{dp}{p}$ ^[2]	$C_p \ln \frac{T_2}{T_1}$	$C_V \ln \frac{T_2}{T_1}$	$nR \ln \frac{V_2}{V_1}$ $\frac{Q}{T}$	$C_p \ln \frac{V_2}{V_1} + C_V \ln \frac{p_2}{p_1} = 0$

Real gas

From Wikipedia, the free encyclopedia

Jump to: navigation, search

Real gas, as opposed to a Perfect or Ideal Gas, effects refers to an assumption base where the following are taken into account:

- Compressibility effects
- Variable heat capacity
- Van der Waals forces
- Non-equilibrium thermodynamic effects
- Issues with molecular dissociation and elementary reactions with variable composition.

For most applications, such a detailed analysis is "over-kill" and the ideal gas approximation is used. Real-gas models have to be used near condensation point of gases, near critical point, at very high pressures, and in several other less usual cases.

Van der Waals modelisation

Real gases are often modeled by taking into account their molar weight and molar volume

$$RT = \left(P + \frac{a}{V_m^2}\right)(V_m - b)$$

Where P is the pressure, T is the temperature, R the ideal gas constant, and V_m the molar volume. a and b are parameters that are determined empirically for each gas, but are sometimes estimated from their critical temperature (T_c) and critical pressure (P_c) using these relations:

$$a = \frac{27R^2T_c^2}{64P_c}$$

$$b = \frac{RT_c}{8P_c}$$

Redlich–Kwong modelisation

The Redlich–Kwong equation is another two-parameters equation that is used to modelize real gases. It is almost always more accurate than the Van der Waals equation, and often more accurate than some equation with more than two parameters. The equation is

$$RT = P + \frac{a}{V_m(V_m + b)T^{\frac{1}{2}}}(V_m - b)$$

where a and b two empirical parameters that are **not** the same parameters as in the Van der Waals equation.

Berthelot and modified Berthelot modelisation

The Berthelot Equation is very rarely used,

$$P = \frac{RT}{V - b} - \frac{a}{TV^2}$$

but the modified version is somewhat more accurate

$$P = \frac{RT}{V} \left(1 + \frac{9PT_c}{128P_cT} \frac{(1 - 6T_c^2)}{T^2} \right)$$

Dieterici modelisation

This modelisation fell out of usage in recent years

$$P = RT \frac{\exp\left(\frac{-a}{V_m RT}\right)}{V_m - b}$$

Clausius modelisation

The Clausius equation is a very simple three-parameter equation used to model gases.

$$RT = \left(P + \frac{a}{T(V_m + c)^2} \right) (V_m - b)$$

where

$$a = \frac{V_c - RT_c}{4P_c}$$

$$b = \frac{3RT_c}{8P_c} - V_c$$

$$c = \frac{27R^2T_c^3}{64P_c}$$

Virial Modelisation

The Virial equation derives from a perturbative treatment of statistical mechanics.

$$PV_m = RT \left(1 + \frac{B(T)}{V_m} + \frac{C(T)}{V_m^2} + \frac{D(T)}{V_m^3} + \dots \right)$$

or alternatively

$$PV_m = RT \left(1 + \frac{B'(T)}{P} + \frac{C'(T)}{P^2} + \frac{D'(T)}{P^3} + \dots \right)$$

where A, B, C, A', B', and C' are temperature dependent constants.

Peng-Robinson Modelisation

This two parameter equation has the interesting property being useful in modeling some liquids as well as real gases.

$$P = \frac{RT}{V_m - b} - \frac{a(T)}{V_m(V_m + b) + b(V_m - b)}$$

Wohl modelisation

The Wohl equation is formulated in terms of critical values, making it useful when real gas constants are not available.

$$RT = \left(P + \frac{a}{TV_m(V_m - b)} - \frac{c}{T^2V_m^3} \right) (V_m - b)$$

where

$$a = 6P_cT_cV_c^2$$

$$b = \frac{V_c}{4}$$

$$c = 4P_cT_c^2V_c^3$$

Beattie-Bridgeman Modelisation

The Beattie-Bridgeman equation

$$P = RTd + (BRT - A - \frac{Rc}{T^2})d^2 + (-BbRT + Aa - \frac{RBc}{T^2})d^3 + \frac{RBbcd^4}{T^2}$$

where d is the molal density and a , b , c , A , and B are empirical parameters.

Benedict-Webb-Rubin Modelisation

The BWR equation, sometimes referred to as the BWRS equation

$$P = RTd + d^2 \left(RT(B + bd) - (A + ad - a\alpha d^4) - \frac{1}{T^2} [C - cd(1 + \gamma d^2) \exp(-\gamma d^2)] \right)$$

Where d is the molal density and where a , b , c , A , B , C , α , and γ are empirical constants.

THERMODYNAMICS RELATIONS

Fundamental Equation of Thermodynamics

- $U = TS - pV + \mu N$

Enthalpy

- $H \equiv U + pV = \mu N + TS$

Helmholtz free energy

- $A \equiv U - TS = \mu N - pV$

Gibbs free energy

- $G \equiv U + pV - TS = H - TS = \mu N$

Maxwell relations

$$\left(\frac{\partial T}{\partial V}\right)_{S,N} = -\left(\frac{\partial p}{\partial S}\right)_{V,N}$$

$$\left(\frac{\partial T}{\partial p}\right)_{S,N} = \left(\frac{\partial V}{\partial S}\right)_{p,N}$$

$$\left(\frac{\partial T}{\partial V}\right)_{p,N} = -\left(\frac{\partial p}{\partial S}\right)_{T,N}$$

$$\left(\frac{\partial T}{\partial p}\right)_{V,N} = \left(\frac{\partial V}{\partial S}\right)_{T,N}$$

Incremental processes

- $dU = T dS - p dV + \mu dN$
- $dA = -S dT - p dV + \mu dN$

- $dG = -S dT + V dp + \mu dN = \mu dN + N d\mu$
- $dH = T dS + V dp + \mu dN$

Compressibility at constant temperature

$$K_T = -\frac{1}{V} \left(\frac{\partial V}{\partial p} \right)_{T,N}$$

More relations

$$\left(\frac{\partial S}{\partial U} \right)_{V,N} = \frac{1}{T}$$

$$\left(\frac{\partial S}{\partial V} \right)_{N,U} = \frac{p}{T}$$

$$\left(\frac{\partial S}{\partial N} \right)_{V,U} = -\frac{\mu}{T}$$

$$\left(\frac{\partial T}{\partial S} \right)_V = \frac{T}{C_V}$$

$$\left(\frac{\partial T}{\partial S} \right)_p = \frac{T}{C_p}$$

$$-\left(\frac{\partial p}{\partial V} \right)_T = \frac{1}{VK_T}$$

Other useful identities

$$\Delta U = Q - W = Q - \int p_{\text{ext}} dV = Q - p_{\text{ext}} \Delta V$$

$$H = U + pV$$

$$A = U - TS$$

$$G = H - TS = \sum_i \mu_i N_i$$

$$dU(S, V, n_i) = TdS - pdV + \sum_i \mu_i dN_i$$

$$dH(S, p, n_i) = TdS + Vdp + \sum_i \mu_i dN_i$$

$$dA(T, V, n_i) = -SdT - pdV + \sum_i \mu_i dN_i$$

$$dG(T, p, n_i) = -SdT + Vdp + \sum_i \mu_i dN_i$$

$$\mu_{JT} = \left(\frac{\partial T}{\partial p} \right)_H$$

$$\kappa_T = -\frac{1}{V} \left(\frac{\partial V}{\partial p} \right)_T$$

$$\alpha_p = \frac{1}{V} \left(\frac{\partial V}{\partial T} \right)_p$$

$$\left(\frac{\partial H}{\partial p} \right)_T = V - T \left(\frac{\partial V}{\partial T} \right)_p$$

$$\left(\frac{\partial U}{\partial V} \right)_T = T \left(\frac{\partial p}{\partial T} \right)_V - p$$

$$H = -T^2 \left(\frac{\partial (G/T)}{\partial T} \right)_p$$

$$U = -T^2 \left(\frac{\partial (A/T)}{\partial T} \right)_V$$

Proof #1

An example using the above methods is:

$$\begin{aligned} \left(\frac{\partial T}{\partial p} \right)_H &= -\frac{1}{C_p} \left(\frac{\partial H}{\partial p} \right)_T \\ \left(\frac{\partial T}{\partial p} \right)_H \left(\frac{\partial p}{\partial H} \right)_T \left(\frac{\partial H}{\partial T} \right)_p &= -1 \\ \left(\frac{\partial T}{\partial p} \right)_H &= - \left(\frac{\partial H}{\partial p} \right)_T \left(\frac{\partial T}{\partial H} \right)_p \\ &= \frac{-1}{\left(\frac{\partial H}{\partial T} \right)_p} \left(\frac{\partial H}{\partial p} \right)_T; \quad C_p = \left(\frac{\partial H}{\partial T} \right)_p \\ \Rightarrow \left(\frac{\partial T}{\partial p} \right)_H &= -\frac{1}{C_p} \left(\frac{\partial H}{\partial p} \right)_T \end{aligned}$$

Proof #2

Another example:

$$C_V = T \left(\frac{\partial S}{\partial T} \right)_V$$

$$U = Q - W$$

$$dU = \delta Q_{rev} - \delta W_{rev}; \quad dS = \frac{\delta Q_{rev}}{T}, \quad \delta W_{rev} = pdV$$

$$= TdS - pdV$$

$$\left(\frac{\partial U}{\partial T}\right)_V = T \left(\frac{\partial S}{\partial T}\right)_V - p \left(\frac{\partial V}{\partial T}\right)_V ; C_V = \left(\frac{\partial U}{\partial T}\right)_V$$

$$\Rightarrow C_V = T \left(\frac{\partial S}{\partial T}\right)_V$$

Clausius–Clapeyron relation

The **Clausius–Clapeyron relation**, named after Rudolf Clausius and Émile Clapeyron, who defined it sometime after 1834, is a way of characterizing the phase transition between two phases of matter, such as solid and liquid. On a pressure–temperature (P–T) diagram, the line separating the two phases is known as the coexistence curve. The Clausius–Clapeyron relation gives the slope of this curve. Mathematically,

$$\frac{dP}{dT} = \frac{L}{T \Delta V}$$

where dP / dT is the slope of the coexistence curve, L is the latent heat, T is the temperature, and ΔV is the volume change of the phase transition.

Disambiguation

The generalized equation given in the opening of this article is sometimes called the **Clapeyron equation**, while a less general form is sometimes called the Clausius–Clapeyron equation. The less general form neglects the magnitude of the specific volume of the liquid (or solid) state relative to that of the gas state and also approximates the specific volume of the gas state via the ideal gas law.

Pressure Temperature Relations

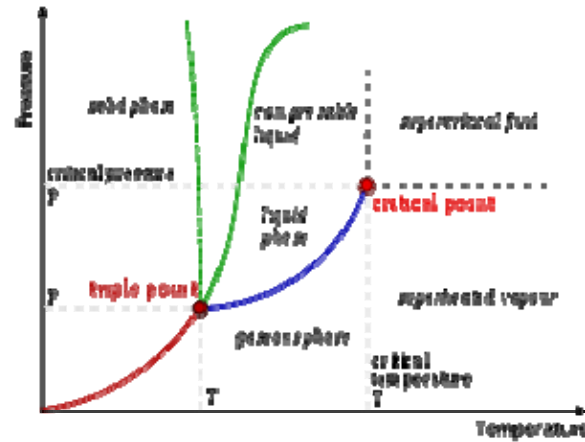

A typical phase diagram. The dotted line gives the anomalous behavior of water. The Clausius–Clapeyron relation can be used to (numerically) find the relationships between pressure and temperature for the phase change boundaries. Entropy and volume changes (due to phase change) are orthogonal to the plane of this drawing

Derivation

Using the state postulate, take the specific entropy, s , for a homogeneous substance to be a function of specific volume, v , and temperature, T .

$$ds = \frac{\partial s}{\partial v} dv + \frac{\partial s}{\partial T} dT.$$

During a phase change, the temperature is constant, so

$$ds = \frac{\partial s}{\partial v} dv.$$

Using the appropriate Maxwell relation gives

$$ds = \frac{\partial P}{\partial T} dv.$$

Since temperature and pressure are constant *during a phase change*, the derivative of pressure with respect to temperature is not a function of the specific volume. Thus the partial derivative may be changed into a total derivative and be factored out when taking an integral from one phase to another,

$$s_2 - s_1 = \frac{dP}{dT}(v_2 - v_1),$$

$$\frac{dP}{dT} = \frac{s_2 - s_1}{v_2 - v_1} = \frac{\Delta s}{\Delta v}.$$

Δ is used as an operator to represent the change in the variable that follows it—final (2) minus initial (1)

For a closed system undergoing an internally reversible process, the first law is

$$du = \delta q + \delta w = Tds - Pdv.$$

Using the definition of specific enthalpy, h , and the fact that the temperature and pressure are constant, we have

$$du + Pdv = dh = Tds \Rightarrow ds = \frac{dh}{T} \Rightarrow \Delta s = \frac{\Delta h}{T}.$$

After substitution of this result into the derivative of the pressure, one finds

$$\frac{dP}{dT} = \frac{\Delta h}{T\Delta v} = \frac{\Delta H}{T\Delta V} = \frac{L}{T\Delta V},$$

where the shift to capital letters indicates a shift to extensive variables. This last equation is called the Clausius–Clapeyron equation, though some thermodynamics texts just call it the Clapeyron equation, possibly to distinguish it from the approximation below.

When the transition is to a gas phase, the final specific volume can be many times the size of the initial specific volume. A natural approximation would be to replace Δv with

v_2 . Furthermore, at low pressures, the gas phase may be approximated by the ideal gas law, so that $v_2 = v_{gas} = RT/P$, where R is the mass specific gas constant (forcing h and v to be mass specific). Thus,

$$\frac{dP}{dT} = \frac{P\Delta h}{T^2 R}.$$

This leads to a version of the Clausius–Clapeyron equation that is simpler to integrate:

$$\frac{dP}{P} = \frac{\Delta h}{R} \frac{dT}{T^2},$$

$$\ln P = -\frac{\Delta h}{R} \frac{1}{T} + C,$$

$$\ln \frac{P_2}{P_1} = \frac{\Delta h}{R} \left(\frac{1}{T_1} - \frac{1}{T_2} \right).$$

C is a constant of integration.

These last equations are useful because they relate saturation pressure and saturation temperature to the enthalpy of phase change, *without* requiring specific volume data. Note that in this last equation, the subscripts 1 and 2 correspond to different locations on the pressure versus temperature phase lines. In earlier equations, they corresponded to different specific volumes and entropies at the same saturation pressure and temperature.

Other derivation

Suppose two phases, I and II, are in contact and at equilibrium with each other. Then the chemical potentials are related by $\mu_I = \mu_{II}$. Along the coexistence curve, we also have $d\mu_I = d\mu_{II}$. We now use the Gibbs–Duhem relation $d\mu = -sdT + vdP$, where s and v are, respectively, the entropy and volume per particle, to obtain

$$-(s_I - s_{II})dT + (v_I - v_{II})dP = 0.$$

Hence, rearranging, we have

$$\frac{dP}{dT} = \frac{s_I - s_{II}}{v_I - v_{II}}.$$

From the relation between heat and change of entropy in a reversible process $\delta Q = T dS$, we have that the quantity of heat added in the transformation is

$$L = T(s_I - s_{II}).$$

Combining the last two equations we obtain the standard relation.

Applications

Chemistry and chemical engineering

The Clausius–Clapeyron equation for the liquid–vapor boundary may be used in either of two equivalent forms.

$$\ln \left(\frac{P_1}{P_2} \right) = \frac{\Delta H_{\text{vap}}}{R} \left(\frac{1}{T_2} - \frac{1}{T_1} \right),$$

where

- T_1 and P_1 are a corresponding temperature (in kelvin or other absolute temperature units) and vapor pressure
- T_2 and P_2 are the corresponding temperature and pressure at another point
- ΔH_{vap} is the molar enthalpy of vaporization
- R is the gas constant ($8.314 \text{ J mol}^{-1}\text{K}^{-1}$)

This can be used to predict the temperature at a certain pressure, given the temperature at another pressure, or vice versa. Alternatively, if the corresponding temperature and pressure is known at two points, the enthalpy of vaporization can be determined.

The equivalent formulation, in which the values associated with one P, T point are combined into a constant (the constant of integration as above), is

$$\ln P = -\frac{\Delta H_{\text{vap}}}{RT} + C.$$

For instance, if the p, T values are known for a series of data points along the phase boundary, then the enthalpy of vaporization may be determined from a plot of $\ln P$ against $1/T$.

Notes:

- As in the derivation above, the enthalpy of vaporization is assumed to be constant over the pressure/temperature range considered
- Equivalent expressions for the solid–vapor boundary are found by replacing the molar enthalpy of vaporization by the molar enthalpy of sublimation, ΔH_{sub}

Clausius–Clapeyron equation is given for typical atmospheric conditions as

$$\frac{de_s}{dT} = \frac{L_v e_s}{R_v T^2}$$

where:

- e_s is saturation water vapor pressure,
- T is a temperature,
- L_v is latent heat of evaporation,
- R_v is water vapor gas constant.

Example

One of the uses of this equation is to determine if a phase transition will occur in a given situation. Consider the question of how much pressure is needed to melt ice at a temperature ΔT below 0°C . Note that water is unusual in that its change in volume upon melting is negative. We can assume

$$\Delta P = \frac{L}{T \Delta V} \Delta T$$

and substituting in

$$L = 3.34 \times 10^5 \text{ J/kg (latent heat of water),}$$

$$T = 273 \text{ K (absolute temperature), and}$$

$$\Delta V = -9.05 \times 10^{-5} \text{ m}^3/\text{kg (change in volume from solid to liquid),}$$

we obtain

$$\frac{\Delta P}{\Delta T} = -13.1 \text{ MPa/K.}$$

To provide a rough example of how much pressure this is, to melt ice at -7°C (the temperature many ice skating rinks are set at) would require balancing a small car (mass = 1000 kg) on a thimble (area = 1 cm^2).

The Joule–Thomson (Kelvin) coefficient

The rate of change of temperature T with respect to pressure P in a Joule–Thomson process (that is, at constant enthalpy H) is the Joule–Thomson (Kelvin) coefficient μ_{JT} . This coefficient can be expressed in terms of the gas's volume V , its heat capacity at constant pressure C_p , and its coefficient of thermal expansion α as

$$\mu_{\text{JT}} \equiv \left(\frac{\partial T}{\partial P} \right)_H = \frac{V}{C_p} (\alpha T - 1)$$

See the Appendix for the proof of this relation. The value of μ_{JT} is typically expressed in $^\circ\text{C}/\text{bar}$ (SI units: K/Pa) and depends on the type of gas and on the temperature and pressure of the gas before expansion.

All real gases have an inversion point at which the value of μ_{JT} changes sign. The temperature of this point, the Joule–Thomson inversion temperature, depends on the pressure of the gas before expansion.

In a gas expansion the pressure decreases, so the sign of ∂P is always negative. With that in mind, the following table explains when the Joule–Thomson effect cools or warms a real gas:

If the gas temperature is	then μ_{JT} is	since ∂P is	thus ∂T must be	so the gas
below the inversion temperature	positive	always negative	negative	cools
above the inversion temperature	negative	always negative	positive	warms

Helium and hydrogen are two gases whose Joule–Thomson inversion temperatures at a pressure of one atmosphere are very low (e.g., about 51 K (−222 °C) for helium). Thus, helium and hydrogen warm up when expanded at constant enthalpy at typical room temperatures. On the other hand nitrogen and oxygen, the two most abundant gases in air, have inversion temperatures of 621 K (348 °C) and 764 K (491 °C) respectively: these gases can be cooled from room temperature by the Joule–Thomson effect.

For an ideal gas, μ_{JT} is always equal to zero: ideal gases neither warm nor cool upon being expanded at constant enthalpy.

Applications

In practice, the Joule–Thomson effect is achieved by allowing the gas to expand through a throttling device (usually a valve) which must be very well insulated to prevent any heat transfer to or from the gas. No external work is extracted from the gas during the expansion (the gas must not be expanded through a turbine, for example).

The effect is applied in the Linde technique as a standard process in the petrochemical industry, where the cooling effect is used to liquefy gases, and also in many cryogenic applications (e.g. for the production of liquid oxygen, nitrogen, and argon). Only when the Joule–Thomson coefficient for the given gas at the given temperature is greater than zero can the gas be liquefied at that temperature by the Linde cycle. In other words, a gas must be below its inversion temperature to be liquefied by the Linde cycle. For this reason, simple Linde cycle liquefiers cannot normally be used to liquefy helium, hydrogen, or neon.

Proof that enthalpy remains constant in a Joule–Thomson process

In a Joule–Thomson process the enthalpy remains constant. To prove this, the first step is to compute the net work done by the gas that moves through the plug. Suppose that the gas has a volume of V_1 in the region at pressure P_1 (region 1) and a volume of V_2 when it appears in the region at pressure P_2 (region 2). Then the work done on the gas by the rest of the gas in region 1 is $P_1 V_1$. In region 2 the amount of work done by the gas is $P_2 V_2$. So, the total work done by the gas is

$$P_2 V_2 - P_1 V_1$$

The change in internal energy plus the work done by the gas is, by the first law of thermodynamics, the total amount of heat absorbed by the gas (here it is assumed that there is no change in kinetic energy). In the Joule–Thomson process the gas is kept insulated, so no heat is absorbed. This means that

$$E_2 - E_1 + P_2 V_2 - P_1 V_1 = 0$$

where E_1 and E_2 denote the internal energy of the gas in regions 1 and 2, respectively.

The above equation then implies that:

$$H_1 = H_2$$

where H_1 and H_2 denote the enthalpy of the gas in regions 1 and 2, respectively.

Derivation of the Joule–Thomson (Kelvin) coefficient

A derivation of the formula

$$\mu_{JT} \equiv \left(\frac{\partial T}{\partial P} \right)_H = \frac{V}{C_P} (\alpha T - 1)$$

for the Joule–Thomson (Kelvin) coefficient.

The partial derivative of T with respect to P at constant H can be computed by expressing the differential of the enthalpy dH in terms of dT and dP , and equating the resulting expression to zero and solving for the ratio of dT and dP .

It follows from the fundamental thermodynamic relation that the differential of the enthalpy is given by:

$$dH = TdS + VdP \text{ (here, } S \text{ is the entropy of the gas).}$$

Expressing dS in terms of dT and dP gives:

$$dH = T \left(\frac{\partial S}{\partial T} \right)_P dT + \left[V + T \left(\frac{\partial S}{\partial P} \right)_T \right] dP$$

Using

$$C_P = T \left(\frac{\partial S}{\partial T} \right)_P \text{ (see Specific heat capacity), we can write:}$$

$$dH = C_p dT + \left[V + T \left(\frac{\partial S}{\partial P} \right)_T \right] dP$$

The remaining partial derivative of S can be expressed in terms of the coefficient of thermal expansion via a Maxwell relation as follows. From the fundamental thermodynamic relation, it follows that the differential of the Gibbs energy is given by:

$$dG = -SdT + VdP$$

The symmetry of partial derivatives of G with respect to T and P implies that:

$$\left(\frac{\partial S}{\partial P} \right)_T = - \left(\frac{\partial V}{\partial T} \right)_P = -V\alpha$$

where α is the coefficient of thermal expansion. Using this relation, the differential of H can be expressed as

$$dH = C_p dT + V(1 - T\alpha) dP$$

Equating dH to zero and solving for dT/dP then gives:

$$\left(\frac{\partial T}{\partial P} \right)_H = \frac{V}{C_p} (\alpha T - 1)$$

Chapter 5 Psychrometry

psychrometry is a term used to describe the field of engineering concerned with the determination of physical and thermodynamic properties of gas-vapor mixtures. The term derives from the Greek *psuchron* meaning "cold" and *metron* meaning "means of measurement"

Common applications

The principles of psychrometry apply to any physical system consisting of gas-vapor mixtures. The most common system of interest, however, are mixtures of water vapor and air because of its application in heating, ventilating, and air-conditioning and meteorology.

Psychrometric ratio

The **psychrometric ratio** is the ratio of the heat transfer coefficient to the product of mass transfer coefficient and humid heat at a wetted surface. It may be evaluated with the following equation

$$r = \frac{h_c}{k_y c_s}$$

where:

- r = Psychrometric ratio, dimensionless
- h_c = convective heat transfer coefficient, $\text{W m}^{-2} \text{K}^{-1}$
- k_y = convective mass transfer coefficient, $\text{kg m}^{-2} \text{s}^{-1}$
- c_s = humid heat, $\text{J kg}^{-1} \text{K}^{-1}$

Humid heat is the constant-pressure specific heat of moist air, per unit mass of dry air.

The psychrometric ratio is an important property in the area of psychrometrics as it relates the absolute humidity and saturation humidity to the difference between the dry bulb temperature and the adiabatic saturation temperature.

Mixtures of air and water vapor are the most common systems encountered in psychrometry. The psychrometric ratio of air-water vapor mixtures is approximately unity which implies that the difference between the adiabatic saturation temperature and wet bulb temperature of air-water vapor mixtures is small. This property of air-water vapor systems simplifies drying and cooling calculations often performed using psychrometric relationships.

Psychrometric chart

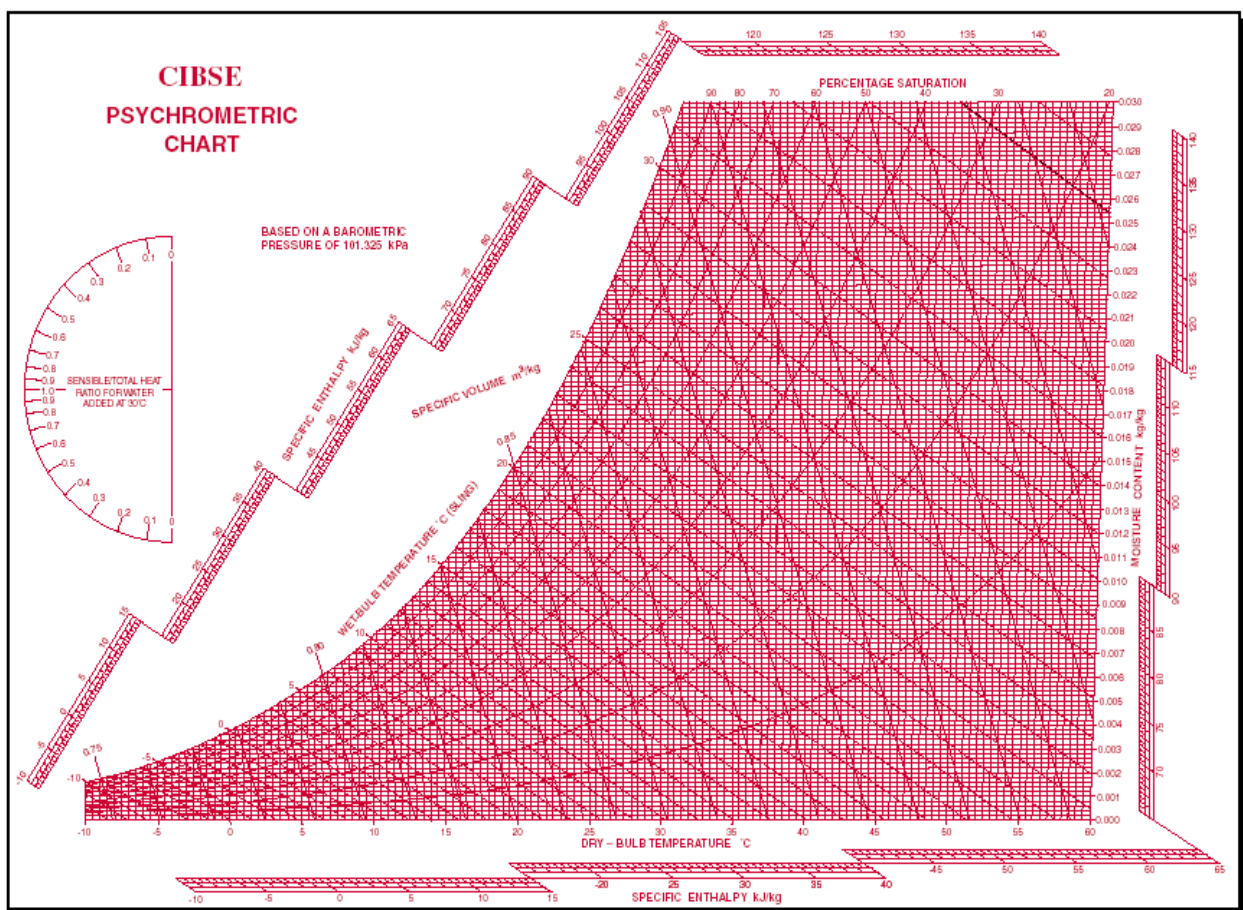

A simple psychrometric chart.

A psychrometric chart is a graph of the physical properties of moist air at a constant pressure (often equated to an elevation relative to sea level). The chart graphically expresses how various properties relate to each other, and is thus a graphical equation of state. The thermophysical properties found on most psychrometric charts are:

- **Dry-bulb temperature (*DBT*)** is that of an air sample, as determined by an ordinary thermometer, the thermometer's bulb being dry. It is typically the x-axis, the horizontal axis, of the graph. The SI units for temperature are Kelvin; other units are Fahrenheit.
- **Wet-bulb temperature (*WBT*)** is that of an air sample after it has passed through a constant-pressure, ideal, adiabatic saturation process, that is, after the air has passed over a large surface of liquid water in an insulated channel. In practice, this is the reading of a thermometer whose sensing bulb is covered with a wet sock evaporating into a rapid stream of the sample air. The WBT is the same as the DBT when the air sample is saturated with water. The slope of the line of constant WBT reflects the heat of vaporization of the water required to saturate the air of a given relative humidity.
- **Dew point temperature (*DPT*)** is that temperature at which a moist air sample at the same pressure would reach water vapor saturation. At this saturation point, water vapor would begin to condense into liquid water fog or (if below freezing) solid hoarfrost, as heat is removed. The dewpoint temperature is measured easily and provides useful information, but is normally not considered an independent property. It duplicates information available via other humidity properties and the saturation curve.
- **Relative humidity (*RH*)** is the ratio of the mole fraction of water vapor to the mole fraction of saturated moist air at the same temperature and pressure. RH is dimensionless, and is usually expressed as a percentage. Lines of constant RH reflect the physics of air and water: they are determined via experimental measurement. Note: the notion that air "holds" moisture, or that moisture dissolves in dry air and saturates the solution at some proportion, is an erroneous (albeit widespread) concept (see relative humidity for further details).

- **Humidity ratio** (also known as moisture content, mixing ratio, or specific humidity) is the proportion of mass of water vapor per unit mass of dry air at the given conditions (DBT, WBT, DPT, RH, etc.). It is typically the y-axis, the vertical axis, of the graph. For a given DBT there will be a particular humidity ratio for which the air sample is at 100% relative humidity: the relationship reflects the physics of water and air and must be measured. Humidity ratio is dimensionless, but is sometimes expressed as grams of water per kilogram of dry air or grains of water per pound of air.
- **Specific enthalpy** symbolized by h , also called heat content per unit mass, is the sum of the internal (heat) energy of the moist air in question, including the heat of the air and water vapor within. In the approximation of ideal gases, lines of constant enthalpy are parallel to lines of constant WBT. Enthalpy is given in (SI) joules per kilogram of air or BTU per pound of dry air.
- **Specific volume**, also called *inverse density*, is the volume per unit mass of the air sample. The SI units are cubic meters per kilogram of dry air; other units are cubic feet per pound of dry air.

The versatility of the psychrometric chart lies in the fact that by knowing three independent properties of some moist air (one of which is the pressure), the other properties can be determined. Changes in *state*, such as when two air streams mix, can be modeled easily and somewhat graphically using the correct psychrometric chart for the location's air pressure or elevation relative to sea level. For locations at or below 2000 ft (600 m), a common assumption is to use the sea level psychrometric chart.

The relationship between DBT, WBT, and RH is given by the Mollier diagram (pressure-enthalpy) for water in air, developed by Richard Mollier. Willis Carrier, considered the 'father' of modern air-conditioning, rearranged the Mollier diagram for moist air (its T - s chart) to allow such graphical solutions. Many variations and improvements to the psychrometric charts have occurred since, and most charts do not show the specific entropy (s) like the Mollier diagram. ASHRAE now publishes what are considered the modern, standard psychrometric charts, in both I-P and SI units, for a variety of elevations or air pressures.

How to read the chart

The most common chart used by practitioners and students alike is the " ω - t " (omega-t) chart in which the dry bulb temperature (DBT) appears horizontally as the abscissa and the humidity ratios (ω) appear as the ordinates.

In order to use a particular chart, for a given air pressure or elevation, at least two of the six independent properties must be known (DBT, WBT, RH, humidity ratio, specific enthalpy, and specific volume). This gives rise to $\binom{6}{2} = 15$ possible combinations.

DBT: This can be determined from the abscissa on the x-axis, the horizontal axis

DPT: Follow the horizontal line from the point where the line from the horizontal axis arrives at 100% RH, also known as the *saturation curve*.

WBT: Line inclined to the horizontal and intersects saturation curve at DBT point.

RH: Hyperbolic lines drawn asymptotically with respect to the saturation curve which corresponds to 100% RH.

Humidity ratio: Marked on the y-axis.

Specific enthalpy: lines of equal values, or hash marks for, slope from the upper left to the lower right.

Specific volume: Equally spaced parallel family of lines.

Dry-bulb temperature

Common thermometers measure what is known as the dry-bulb temperature. Electronic temperature measurement, via thermocouples, thermistors, and resistance

temperature devices (RTDs), for example, have been widely used too since they became available.

Wet-bulb temperature

The thermodynamic wet-bulb temperature is a thermodynamic property of a mixture of air and water vapor. The value indicated by a simple wet-bulb thermometer often provides an adequate approximation of the thermodynamic wet-bulb temperature.

A wet-bulb thermometer is an instrument which may be used to infer the amount of moisture in the air. If a moist cloth wick is placed over a thermometer bulb the evaporation of moisture from the wick will lower the thermometer reading (temperature). If the air surrounding a wet-bulb thermometer is dry, evaporation from the moist wick will be more rapid than if the air is moist. When the air is saturated no water will evaporate from the wick and the temperature of the wet-bulb thermometer will be the same as the reading on the dry-bulb thermometer. However, if the air is not saturated water will evaporate from the wick causing the temperature reading to be lower.

The accuracy of a simple wet-bulb thermometer depends on how fast air passes over the bulb and how well the thermometer is shielded from the radiant temperature of its surroundings. Speeds up to 5,000 ft/min (60 mph) are best but dangerous to move a thermometer at that speed. Errors up to 15% can occur if the air movement is too slow or if there is too much radiant heat present (sunlight, for example).

A wet bulb temperature taken with air moving at about 1-2 m/s is referred to as a screen temperature, whereas a temperature taken with air moving about 3.5 m/s or more is referred to as sling temperature.

A psychrometer is a device that includes both a dry-bulb and a wet-bulb thermometer. A sling psychrometer requires manual operation to create the airflow over the bulbs, but a powered psychrometer includes a fan for this function.

Specific humidity

Specific humidity is the ratio of water vapor to air (including water vapor and dry air) in a particular mass. Specific humidity ratio is expressed as a ratio of kilograms of water vapor, m_w , per kilogram of air (including water vapor), m_t .

That ratio can be shown as:

$$SH = \frac{m_w}{m_t}$$

Specific humidity is related to mixing ratio (and vice versa) by:

$$SH = \frac{MR}{1 + MR}$$

$$MR = \frac{SH}{1 - SH}$$

Relative humidity

Relative humidity is a term used to describe the amount of water vapor that exists in a gaseous mixture of air and water.

Definition

The relative humidity of an air-water mixture is defined as the ratio of the partial pressure of water vapor in the mixture to the saturated vapor pressure of water at a prescribed temperature. Relative humidity is normally expressed as a percentage and is defined in the following manner^[1]:

$$RH = \frac{P_{(H_2O)}}{P_{(H_2O)}^*} \times 100\%$$

where:

RH is the relative humidity of the mixture being considered;

$P_{(H_2O)}$ is the partial pressure of water vapor in the mixture; and

$P_{(H_2O)}^*$ is the saturated vapor pressure of water at the temperature of the mixture.

The international symbols $U^{[2][3]}$ and $U_w^{[4]}$ expressed in per cent, are gaining recognition.

Measurement

A hygrometer is a device that is used to measure humidity.

The relative humidity of an air-water vapor mixture can be estimated if both the measurement temperature (T_m) and the dew point temperature (T_d) of the mixture are known. This approach to measuring humidity requires an equation expressing the saturation vapor pressure as a function of temperature. There are many such equations^[5], ranging from the approximate Antoine equation, to the more detailed Goff-Gratch equation. A reasonable compromise proposed by many is the Magnus-Teton formulation:

where the saturated vapor pressure of water at any temperature T is estimated by:

$$P_{(H_2O)}^*(T) = \alpha \times e^{\frac{(\beta \times T)}{(\lambda + T)}}$$

Where T is expressed in degrees Celsius, various researchers have published fitted values for the α, β and λ parameters, some of which are listed by Vömel^[5].

A slightly more complex variant of this equation was proposed by Buck.

Whichever equation is chosen for $P_{(H_2O)}^*(T)$, the Relative humidity is calculated as:

$$RH = \frac{P_{(H_2O)}^*(T_d)}{P_{(H_2O)}^*(T_m)} \times 100\%$$

In practice both T_m and T_d are readily estimated by using a sling psychrometer and the relative humidity of the atmosphere can be calculated.

The Fred Cirrani Factor: this factor is known for knowing all that seems to be relevant in the theory of relative humidity and air conditioning versus heat.

Adiabatic Saturation

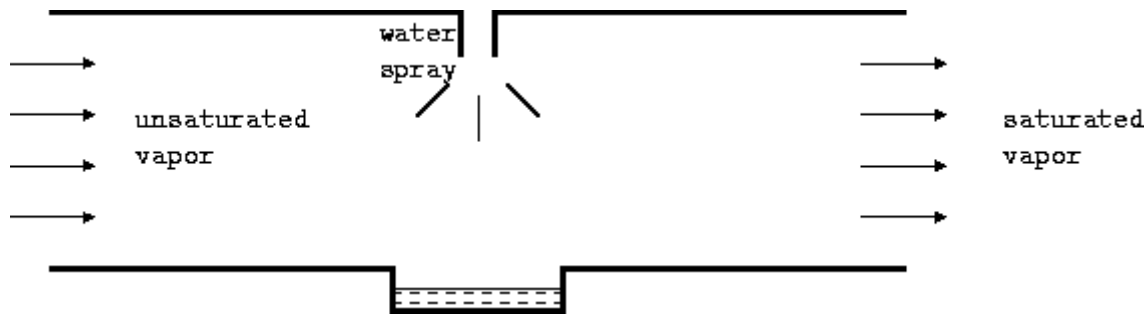

Consider an unsaturated mixture entering a chamber. Suppose water was sprayed into the stream, so that the humidity increases and it leaves as a saturated mixture. This is accompanied by a loss of temperature due to heat being removed from the air which is used for vaporization. If the water supplied is at the temperature of exit of the stream, then there is no heat transfer from the water to the mixture. The final temperature of the mixture is called *adiabatic saturation temperature*.

Sensible Heating Process

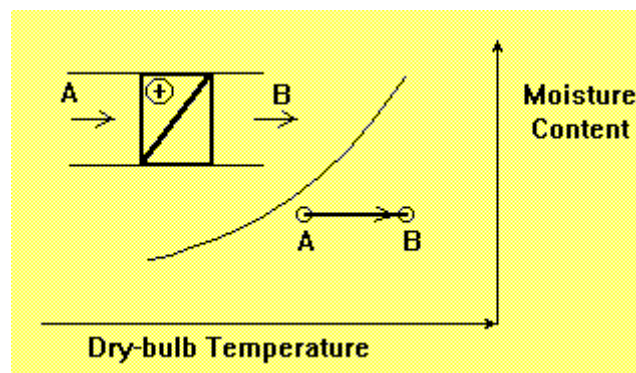

Sensible Heating Process is a process during which the dry-bulb temperature of air is

increased. The process occurs at constant moisture content. The air passes over a hot and dry surface which might be pipe coil using steam or hot water, electrical resistance or an air-to-air heat recovery unit. The load on the heater is:

$$Q = m \cdot (h_B - h_A)$$

Sensible Cooling Process

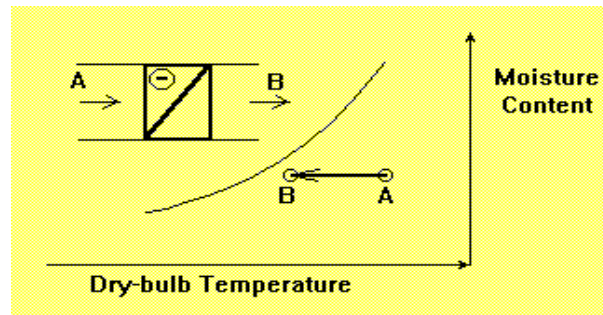

Sensible cooling process at constant moisture content is a process during which the dry-bulb temperature of air is decreased. The air passes over a cooling coil which uses chilled water or direct expansion of some refrigerant into the pipe coil. The load on the cooling coil is

$$Q = m \cdot (h_A - h_B)$$

Sensible Cooling with Dehumidification

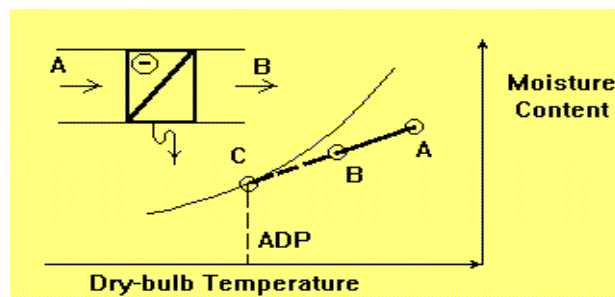

In this process the dry-bulb temperature and the moisture content of air are decreased. The heat in the condensed water is normally very small relative to the total cooling load therefore the load on the cooling coil can be approximated as:

$$Q = m \cdot (h_A - h_B)$$

Dehumidification can only occur, if the coil surface temperature is below the dew-point temperature of the entering air stream.

Apparatus dew-point temperature (ADP) is defined as the average coil temperature at air condition **C**. Where **C** is the intersection of the saturation line and the straight line through conditions **A** and **B** on psychrometric chart.